



SVG-3 Operation Manual



You must read this manual before use
November 2020

Table of Contents

1. Section 1: Description and Principle Operations	3
2. Section 2: Construction	3
3. Section 3: Unpacking and Inspecting	3
4. Section 4: Installation	5
5. Section 5: Operations	5
6. Section 6: Factory Repairs and Calibrations	6
7. Section 7: Understanding Torr	7
8. Section 8: Attachments and Illustrations	7

Section 1: Description and Principles of Operation

The Summit Research SVG-3 is a digital vacuum control instrument highly configurable and capable of driving multiple types of sensors (active, passive, and capacitance manometers).



4 Main Operational Uses:

1. **Display Controller:** for 1-3 active and passive vacuum and pressure gauges
2. **Vacuum Controller:** capable of maintaining vacuum by either throttling a vacuum pump or bleeding air into a vessel
3. **Relay controller:** capable of turning on/off valves and other gauges based on vacuum level
4. **Internet Telemetry Device:** capable of both monitoring and alerting users

The Summit Research SVG-3 has many applications from simple passive sensor monitoring to combining multiple sensors to create a wide range calibration standard that controls vacuum pump down. It uses a modular building block approach to build the most efficient configuration to achieve a task. For example, simply populate it with 2 passive driver cards and 2 chambers can easily be monitored from one device. By default, the SVG-3 has a USB input that allows hardwire digital communication that can be used for logging or control. One of the great values of the SVG-3 is its extensive sensor compatibility. It works with most active gauges sold on the market today including Inficon, MKS and Pfeiffer cold cathode and Pirani gauges. The SVG-3 was built for control and telemetry from the ground up, so configuring USB, Wi-Fi or internet connectivity is a breeze. Below we illustrate 4 common configurations:

Configuration	Why	Example Applications
SVG-3 with one gauge card + one gauge	<ul style="list-style-type: none"> • Simple and safe way to power and read a gauge • Easily connect gauge to computer for USB logging • Output options: actual gauge analog output or options to select a linear output 	A university student is putting together a coating system and needs to measure and record high vacuum data.
SVG-3 with two gauge cards + two capacitance manometers	<ul style="list-style-type: none"> • Simple and safe way to power and read multiple gauges • Easily connect multiple gauges to computer via a single USB cable • <i>Ability to combine 2 capacitance manometers to yield one continuous pressure for the combined ranges</i> 	A firm performing calibrations wants to avoid confusion dealing with different pressure ranges and prefers one combined range.
SVG-3 with one gauge card, gauge, throttle valve controller card, and throttle valve	<ul style="list-style-type: none"> • Enables vacuum pressure control using a standard solenoid valve for throttling pump suction • User can maintain vacuum levels or change levels • <i>Extends life of pump by enabling pump to run closer to its base pressure</i> 	A botanical processor wants to maintain specific pressure levels in a vacuum oven of about 10 Torr to avoid removing target terpenes while still removing only water.
SVG-3 with one gauge card, gauge, bleed valve controller card and VacStable bleed valve with wireless feature	<ul style="list-style-type: none"> • Enables vacuum pressure control using a small bleed valve • User can maintain vacuum levels or change those levels, and its PID response • <i>You can surf over to your gauge, adjust set points and view your process progress anywhere there is internet</i> 	In order to help a manufacturer control their freeze drying process better, they implement this SVG-3 configurations to maintain 300 millitorr in batches to improve consistency, and will always be able to view process status from their cell phone.

Versatility Within Your Reach

The SVG-3 is configured with sensors based on the accuracy and range required to sense vacuum and display the pressure reading in user selectable units of: Torr, mbar, kilopascal or millitorr. The Summit Research SVG-3 can be panel mounted or sit on a bench top. It has an extensive support matrix that

includes most capacitance manometers, active and passive gauges available from Lesker, Agilent, Inficon, MKS and Setra. A support matrix is available in [Section 8](#).

To achieve this versatile functionality, the SVG-3 has a modular building block approach that allows the user to select the hardware necessary for their application.

Section 2: Construction

The SVG-3 consists of the indicating and controlling instrument, the sensor configured, the sensor cable, output interface and an international AC power adapter.

The instrument is housed in a rugged free-standing plastic enclosure. It can either be placed on a desktop or benchtop surface, installed on a laboratory stand with optional lab mount, or can be panel mounted in a 1/8" DIN panel cutout.

SVG-3 Controller: includes a bright white LED display, 4 configuration buttons, USB port, and a 24 Volt power supply.

Versatile Options/Upgrades: Application Based Configuration Options

1. The original SVG-3 controller can read and control up to 3 total sensors:

- a. Up to 3 active capacitance
- b. Up to 3 standard 5 such as the Summit
- c. Up to 3 passive

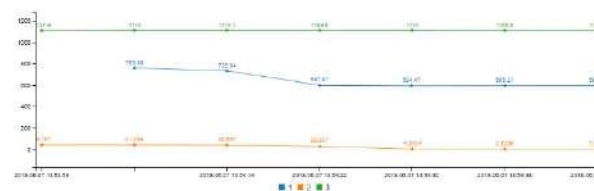

From: To: Max Value:

Time	Reading
2018-06-07 13:54:45	1.5578
2018-06-07 13:54:45	1109.4
2018-06-07 13:54:38	595.78
2018-06-07 13:54:38	595.21
2018-06-07 13:54:38	1108.8
2018-06-07 13:54:38	2.1259
2018-06-07 13:54:30	4.8804

2. **Control up to 2 valves:** 1 card to control up to 2 isolation or vacuum control, bleed to maintain a vacuum
3. **Upper and Lower Set-point** ability to control up to 2 relays

4. **WiFi:** A wireless Ethernet card that enables connecting to your gauge via http or telnet; and enables connectivity to the vacuumnetwork.org cloud monitoring service
5. **Output for PLC integration:** 10 Volt analog output port

gauges or manometers, Research 775i gauges valve control valves for or to apply a level **Control:** The type "C"

Consult the Summit Research website www.Summit Research.com for information about other Summit Research vacuum controllers and gauges.

Section 3: Unpacking and Inspecting

After the instrument is received, it should be carefully unpacked and inspected for damage during shipment and to confirm that all components are present. The Display Unit warranty pertains only to the instrument, and does not cover losses in shipping.

Each SVG-3 should come with:

- Display Controller (black box)
- 10' Sensor cable with modular plugs that mate with the ordered driver cards
- 24 Volt Power Supply (**Always confirm you are using the correct voltage power supply**)
- Rubber feet and mounting hardware
- Quick Start Guide

Section 4: Installation

The instrument should be located in a clean, dry environment for best results. The unit can be panel mounted with the hardware provided in a 1/8" DIN panel cutout (3.64" x 1.78" [92mm x 45 mm]). Alternatively, the unit can be placed on a benchtop by placing the 4 rubber feet included with your gauge on the underside of the unit. Lastly, the SVG-3 can be mounted on a lab pole or lattice system using the optional pole clamp. The gauge tube cable should be identified by wire tags or markings specific to your environment.

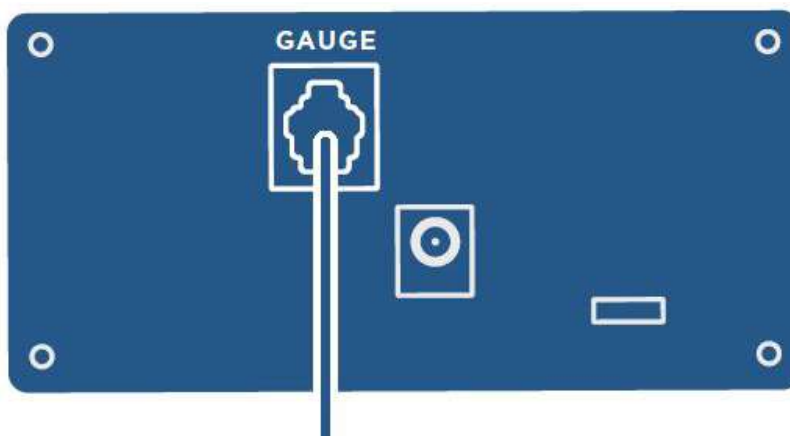

The Display controller can be connected to a computer with a standard micro-B USB cable. The software will automatically download and install. You can open a simple command window like [putty](#) and issue commands to read vacuum and assign set point values.

Please use the supplied AC adapter (power supply) with your Instrument. This adapter provides clean short-protected power to protect and insure proper functioning of the internal circuitry. If you have just one active sensor installed, the gauge menu appears, and the user can easily match one of many sensor types from the front panel.

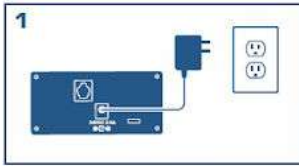

1
Connect power supply to unit, then connect to power supply to wall. Verify that SPARC powers on.

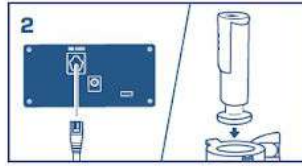

2
Connect sensor cable to the SPARC & plumb the sensor into your vacuum system.

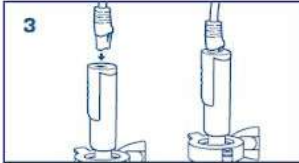

3
Connect the sensor cable to the sensor.



4
Find the "gauge" menu by pressing "select" until the instrument says gauge, then press enter.



5
Using the up/down arrows, select the sensor you plan to use with the SPARC, then press enter.



6
Press select until the measurement is displayed. Verify that the readings make sense.

Menu Tree

Configuration

The SVG-3 can have 1, 2 or 3 sensors configured. These sensors may be individually viewed. While these settings are typically set at the factory, the option exists for the user to change the associated sensor and adjust that sensor type.

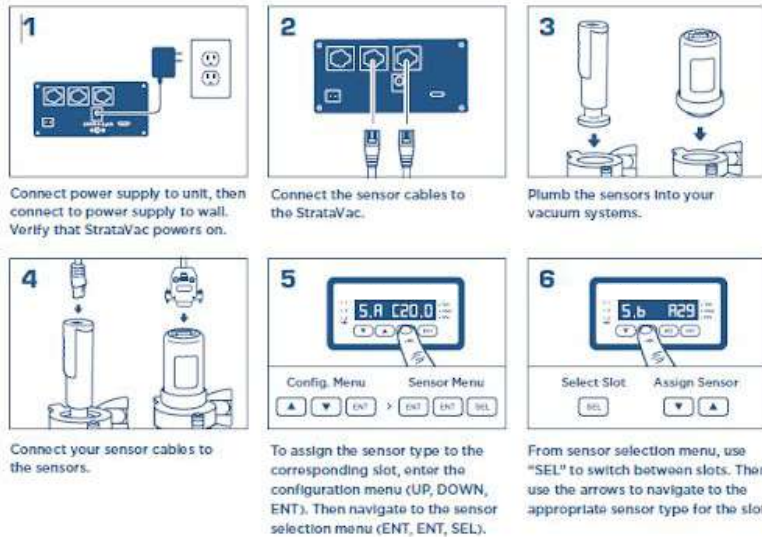

Additionally, in certain cases sensors may be combined to achieve a combined virtual sensor composed of 2 or more sensors. For example, you want to have vacuum control keyed off a larger range of vacuum covered by multiple sensors.

Capacitance Manometer Combination Options	
Combination Driver	Sensors combined
2CM	0.1 Torr + 10 Torr
2CM	10 Torr + 1000 Torr
3CM	0.1 Torr + 10 Torr + 1000 Torr

The sensor in the lowest lettered slot (A, B, C, etc.) on the display of the unit is the default sensor.

Simply use the up and down arrows to display other sensors.

The display below is showing the 3rd sensor. **Note:** once set to a particular sensor, the reading will maintain that sensor until it is changed by the user. However, all live sensor readings are available to their assigned relays, valves and set points as well as to the network and to the USB output.



Section 5: Operation

After installation, the SVG-3 Controller is ready for immediate operation. **NEVER DISCONNECT SENSOR OR OUTPUT WIRES WHILE UNIT IS POWERED UP.** Only connect and disconnect cables with the power to the unit unplugged. Make all connections to sensors and relay outputs with the power disconnected.

In systems with a high risk of contamination (i.e. metalizing, processing, and coating applications), the addition of solenoid or manual valve between the sensor and process contaminates to help isolate and protect the sensor.

How To Change Units Displayed (Torr, mbar, kPa)

1. Press the “sel” key three times during normal operation.
The currently selected units will blink
2. Press the “↑” and “↓” to get to the desired unit.
3. Press “Ent” to complete your selection.

One of the units LEDs to the right of the LCD will always be lit during normal operation to indicate which pressure range the display is indicating.



The LED Display Will Show One Of 4 Indications:

1. A number in decimal or scientific notation displaying the current vacuum pressure
2. A dash in the upper middle or lower left digit showing whether the unit is displaying the current pressure from the first, second, or third sensor (in slot A, B, or C, respectively.)
3. “Error” indicating that the sensor is disconnected or not functioning
4. “Range” indicating that the sensor is out of its useful range. This can be overridden by putting the unit in raw counts mode.

How To Use The SVG-3 With Relays: Upper and Lower Set-Point Control

Install the SVG-3 and the sensor in the vessel closest to the pressure that you care about. Next, wire in the valves.

The set point connections are in the back of the unit. There are 2 rows of pins. The top row of pins is for set point 1, and the bottom row of pins is for set point 2. The top 3 pins are in the order:

1. **Common** – The common line of a switch
2. **N.C.** – Normally closed. This means that above the set point value there is a current path between the common and the N.C. terminal. Put another way the switch is “ON” between these 2 terminals. At the set point value and below (higher vacuum, lower pressure) the connection is open. Put another way, the switch is “OFF” between the common and the N.C. connection at higher vacuum (a lower pressure reading).
3. **N.O.** – Normally open. This means that above the set point value there is no current path between the common and N.O. connection. Put another way the switch is “OFF” between these 2 terminals. When the vacuum indication goes below the set point value (higher vacuum, lower pressure) the current path closes. Put another way the switch is “ON” between the common and N.O. connections at absolute pressure readings below the set point value.

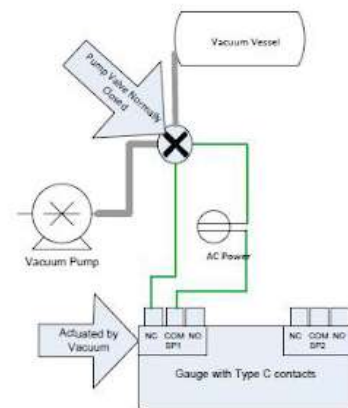
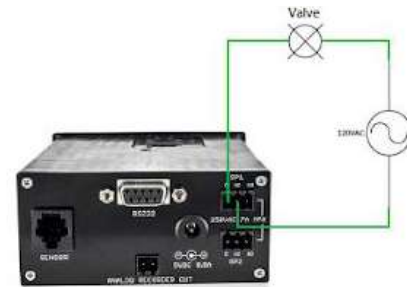

Take care to ensure that the wire connections are made fast, and the voltage and current does not exceed 250V or 7A. If you need to control a device that draws more power (like a vacuum pump or heater), consider another relay in between the Summit Research output and the device to be controlled.

Below is a description of how relays act as a function of vacuum level.

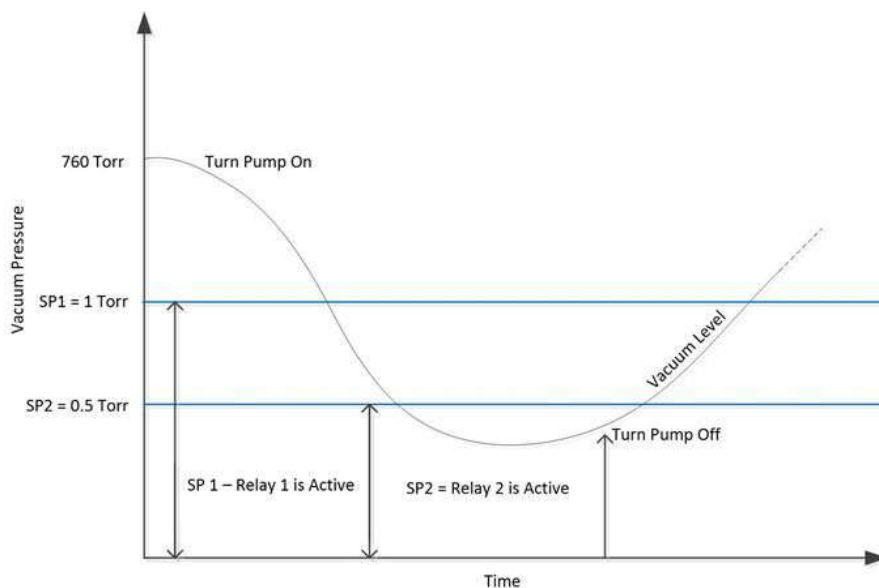

To Use the SVG-3 as a Throttle Type Regulator:

1. Install valve between pump and vessel. **Note:** the Valve in regulation mode is powered directly by the SVG-3, unlike standard relays (which require wiring to an AC or other power source)
2. Install sensor near the vessel
3. Set upper and lower set points
 - a. Click the “sel” button on the display until you see “U”
 - b. Press the up or down arrows until you are satisfied with your set point selection
 - c. Click “enter” when done
 - d. To set the lower set point, click the “sel” button on the display until you see “L”
 - e. Press the “sel” button again to view “L”
 - f. Repeat steps b and c
4. Observe control and adjust as necessary



To navigate to the upper set point, press Select (SEL) until you see “U” on the display.



Use the up/down arrows to change the set point. Once the desired set point is reached, press Enter (ENT) to save.



To navigate to the lower set point, press Select (SEL) until you see “L” on the display.



Repeat step two to set and save the lower set point.

The SVG-3 vacuum regulator enables maintaining a vacuum pressure between two set points. The SVG-3 directly powers a 24 volt valve (1 amp or less) by opening a valve until the lower set point is reached, then closing the valve allowing the system to bleed up

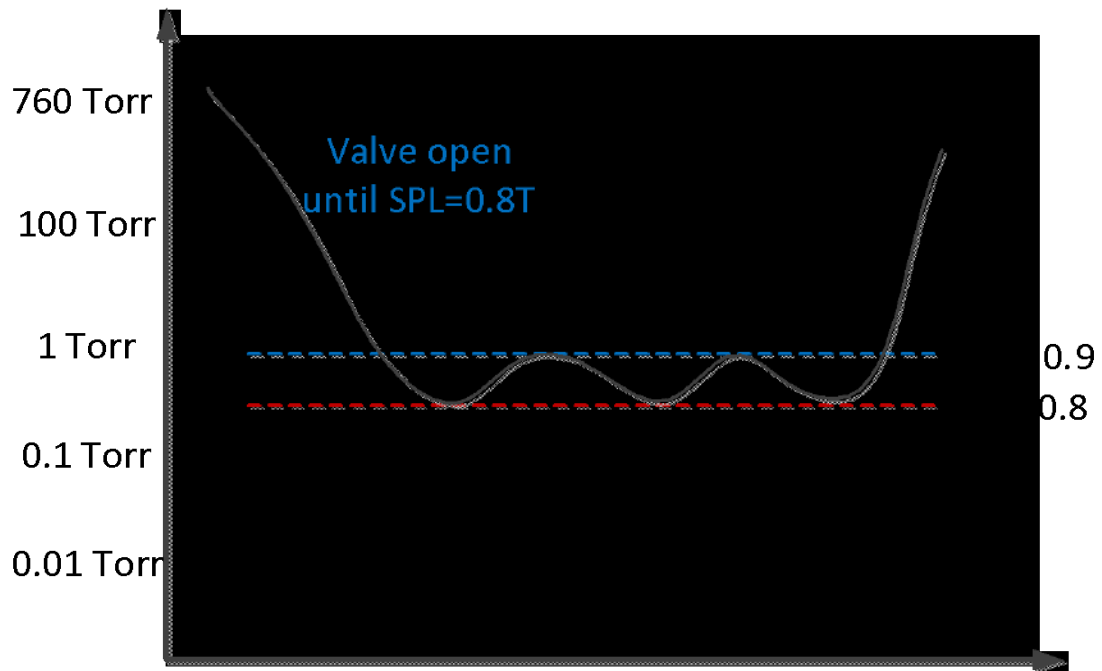

To Use the SVG-3 as a Bleed Type Regulator:

The SVG-3 can operate as a bleed-type vacuum level controller when configured with a bleed valve. The solenoid valve is mounted as close to the vessel as appropriate, with the wires for the solenoid valve terminating on pins 1 & 2 of the 2 position VLC connector. Set the VLC set point by setting "S" in the tune menu to the desired vacuum level you need maintained. The SVG-3 has been tested on vessels from 0.2 Liters to 50 Liters with good success. In many cases, you may not need to touch the PID tuning variables. If the control out of the box isn't optimal, you can change the P, I and D variables to obtain a more desirable result.

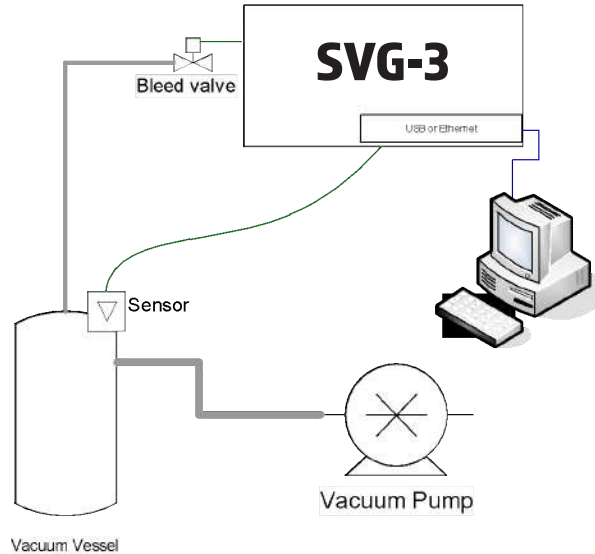

To get to the PID tuning variables, press the “SEL” button until you get to a screen that says “tune”, then hit “ENT”

- The first variable is “S” which is what you would use to adjust the set point for VLC control.
- Hit “Sel” to the desired variable, either “P”, “I”, “D”, or “o”
- When the desired variable is displayed, Press the “ \square ” and “ \square ” to get to the desired value
- Press “ENT” when completed. Not pressing enter will result in no change of PID value.

PID Overview:

PID control is largely used in industry and refers to the variables in the control equation “proportional,” “integral,” and “derivative.” For a PID primer, refer to http://en.wikipedia.org/wiki/PID_controller

- **P:** is implemented as a proportional gain (not as a proportional band). Larger values of P yield smaller error with less stability. The range is 0.01 to 99.99 with units of %.
- **I:** is also a gain. Larger values of I will yield faster response with less stability. The range is 0.00 to 99.99 with units resets/minute
- The **D** Range is 0.00 to 99.99 with units of minutes.
- **O:** is a feed forward term and is especially helpful with smaller vessels. The range is from 0-99, where O=99 is traditional PID without the feed forward effect.

Here are the recommended PID tuning steps:

1. To Start

- a. Start with $P=0.14$, $I = 0.08$, $d=0$ S =Set Point (1 Torr default), $O=0030$
 - b. Increase “O” in increments of 5 until the vacuum level is maintained at $\frac{1}{2}$ Set Point.
 - c. Increase “P” until oscillations observed at about 10% of average reading (not Set Point.. the reading will likely still be lower than set point)
 - d. Set $P=P/2$ (half the oscillation value of “P” obtained above)
 - e. Start with $I=P/4$ (at this point the vacuum level should be approaching the set point)
- 2. Tuning**
- a. If oscillations are greater than desired, decrease “P” 10-20% at a time
 - b. If Vacuum Level is less than the set point, increase I in increments of 20% until convergence at the set point
- 3. Rules of thumb**
- a. If the vacuum level is below the desired set point with maximum values of P & I, then increase “O”
 - b. If greater than preferred oscillations are occurring when $I>P$, try setting $I=P$
 - c. If greater than preferred oscillations are occurring about a set point and $P<1$, reduce “O”

Communication: USB Connectivity

SVG-3 can display vacuum readings on a desktop in real time. To view your vacuum pressures on your desktop, you first must download [PuTTY](#). Once the software is installed on your computer, follow the instructions below.

1. Go to your device manager and review your COMM port

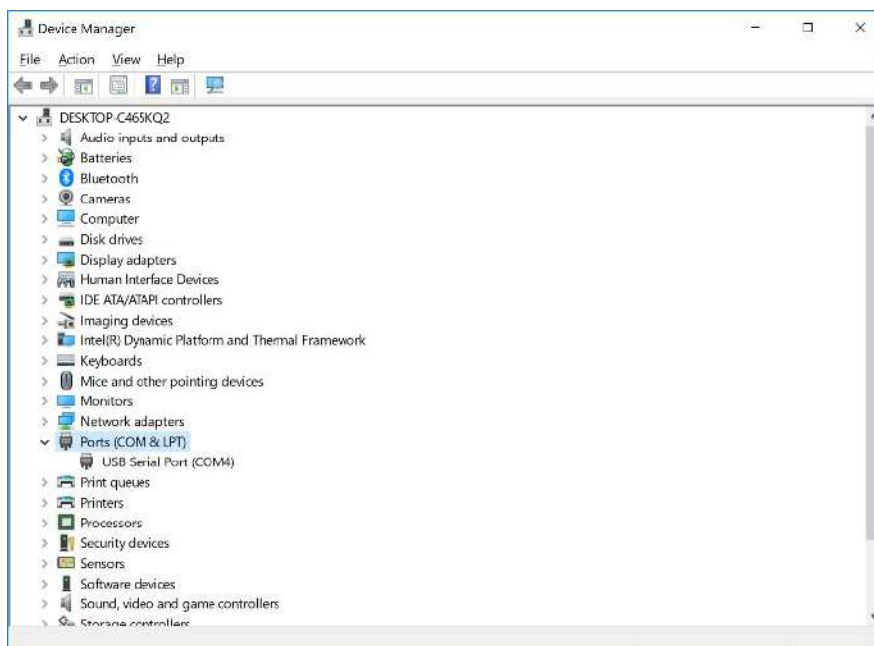

2. Open PuTTY on your desktop



3. Select “serial” as your connection type and set the speed to 115200

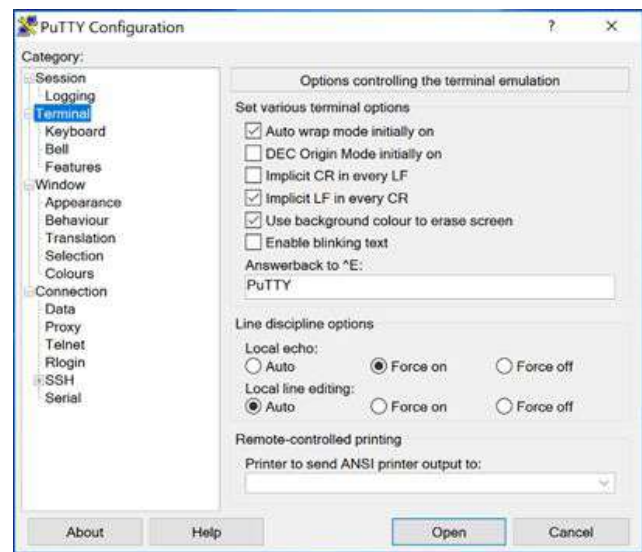
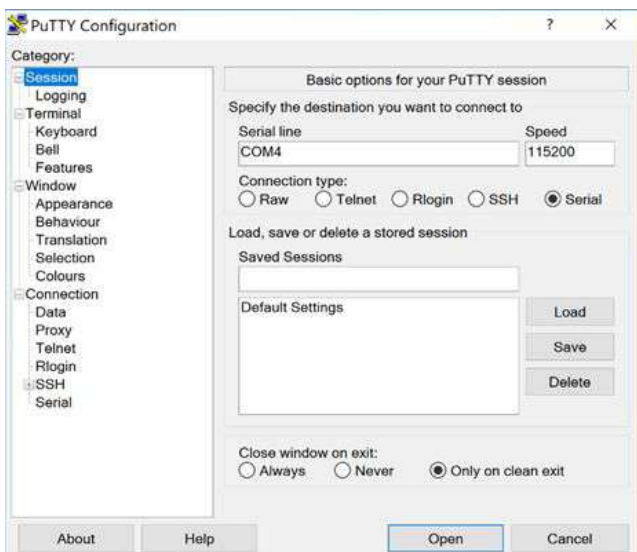

4. Under “Category” on the left, select “terminal” then select various terminal options. Still on this screen, select “force on” as the Local echo line display. Click open.

```

192.168.0.30 - PuTTY
VAC1=388.0400 VAC2=759.4022 VAC3=750.2184 SPU=5.1400 SPL=2.0700
VAC1=389.0471 VAC2=759.4535 VAC3=746.6561 SPU=5.1400 SPL=2.0700
VAC1=388.8254 VAC2=759.3777 VAC3=757.1195 SPU=5.1400 SPL=2.0700
VAC1=388.9439 VAC2=759.3167 VAC3=758.1550 SPU=5.1400 SPL=2.0700
VAC1=389.2839 VAC2=759.3090 VAC3=761.3547 SPU=5.1400 SPL=2.0700
VAC1=389.5392 VAC2=759.3141 VAC3=760.0190 SPU=5.1400 SPL=2.0700
VAC1=389.6327 VAC2=759.3843 VAC3=758.7595 SPU=5.1400 SPL=2.0700
VAC1=389.9755 VAC2=759.2949 VAC3=759.7053 SPU=5.1400 SPL=2.0700
VAC1=390.0746 VAC2=759.3066 VAC3=757.0053 SPU=5.1400 SPL=2.0700
VAC1=390.7358 VAC2=759.4776 VAC3=759.0011 SPU=5.1400 SPL=2.0700
VAC1=390.6849 VAC2=759.4129 VAC3=757.2856 SPU=5.1400 SPL=2.0700
VAC1=390.4573 VAC2=759.2279 VAC3=760.3283 SPU=5.1400 SPL=2.0700
VAC1=391.0159 VAC2=759.3619 VAC3=773.2523 SPU=5.1400 SPL=2.0700
VAC1=391.1296 VAC2=759.3077 VAC3=768.7596 SPU=5.1400 SPL=2.0700
VAC1=391.5724 VAC2=759.3403 VAC3=770.7045 SPU=5.1400 SPL=2.0700
VAC1=391.4987 VAC2=759.2391 VAC3=764.3661 SPU=5.1400 SPL=2.0700
VAC1=391.7511 VAC2=759.2485 VAC3=771.5813 SPU=5.1400 SPL=2.0700
VAC1=392.4893 VAC2=759.3641 VAC3=765.1457 SPU=5.1400 SPL=2.0700
VAC1=392.5623 VAC2=759.2724 VAC3=764.1800 SPU=5.1400 SPL=2.0700

```

5. View your vacuum on your desktop!

SVG-3 "Cheat Sheet"

VAC?	Get vacuum reading.
Vac1?	Get vacuum reading of sensor in first slot (ex: slot A)
Vac2?	Get vacuum reading of sensor in second slot (ex: slot B)
Vac3?	Get vacuum reading of sensor in third slot (ex: slot C)
M?	Get mode setting. Returns "M=A" for automatic mode, Returns "M=M" for manual mode.
M=A	Set mode to automatic.
M=M	Set mode to manual
M=D	Set to diagnostic mode
T?	Get timing setting. This is how frequently we will burp out data in automatic mode, in seconds.
T=.25	Set data burp rate to Four times per second.
T=30	Set data burp rate to twice per minute.
T=60	Set data burp rate to once per minute.
T=600	Set data burp rate to once per 10 minutes.
Accepted range for T is .25 to 600	
U?	Get units setting. Responds appropriately with "U=0", "U=1", or "U=2"

U=0	Set units to Torr
U=1	Set units to mBar
U=2	Set units to kPa

P?	Get P term
P=2.35	Set P term

I?	Get I term
I=16.789	Set I term

D?	Get D term
D=8.087	Set D term

O?	Get O term
O=99	Set O term

S?	Get S term
S=.82	Set S term

SP1?	Get SP1 setting.
SP1=123.456	Set SP1

SP2?	Get SP2 setting.
SP2=34.506	Set SP2

V?	Get the Version, such as K11D13
-----------	---------------------------------

Section 6: Factory Repairs and Calibrations

The vacuum gauge assembly is designed to provide years of trouble-free service, and the liberal internal use of plug-in components make it easily repairable. No field servicing of the unit is recommended, other than replacement of the gauge tube, but factory servicing and calibration are available at a nominal cost.

Summit Research recommends annual calibrations of your gauge/controller. NIST certification with before and after data for cGMP labs is also available.

We are here to help: Phone: 831-226-2948 **Email:** tech@summit-research.tech

Section 7: Understanding Torr

The Display Units are calibrated in microns or "millitorr." What are microns and how do they relate to other measures of pressure and vacuum? Microns are not really a measure of vacuum at all, but rather of absolute pressure. The pressure of the atmosphere is 14.696 or approximately 14.7 pounds per square inch (PSI) at sea

level. This pressure is due to the weight of all the air in the earth's atmosphere above any particular square inch. This 14.696 PSI is equivalent to the pressure produced by a mercury column of approximately 29.92 inches high or .76 meters (about 3/4 of a yard) or 760 millimeters of mercury.

Atmospheric pressure varies greatly with altitude. It decreases approximately 1 inch of mercury per thousand feet of altitude. It also varies widely with local weather conditions. (variations of 1/2 inch in a single day are common.) The word vacuum means pressure lower than atmosphere. However, in describing negative pressure, the atmosphere is only a satisfactory reference if we are dealing with values of vacuum down to about 27 inches of mercury.

Below that, it is better to talk in terms of absolute pressure, starting from absolute zero, which is the approach that Summit Research takes with our display instruments. One TORR is an absolute pressure of one millimeter of mercury. A millitorr is equal to one thousandth of a TORR. A MICRON equals a millitorr. The full-scale reading of a Summit Research gauge is 1999 microns and is equivalent to 1.999 TORR of approximately 2/760 of atmospheric pressure. This is less than .1 inches of mercury, and less than .05 PSI.

One TORR, a commonly used unit, is an absolute pressure of one millimeter of mercury. A millitorr is equal to one thousandth of a TORR. A MICRON is the same as a millitorr. The full-scale reading of a Summit Research is 1999 microns and is equivalent to 1.999 TORR of approximately 2/760 of atmospheric pressure. This is less than .1 inches of mercury, and less than .05 PSI.

Section 8: Attachments and Illustrations

Types of Sensors Supported

Description	Manufacturer	Supported Part Numbers	Sensor Interface	Number Supported	Required SVG-3 Card	Required Adapter	Driver
KJLC Pirani	Lesker	PIR-xx-x	FCC68	3	AG-CM-ST R	none	Pir
KJLC Cold Cathode	Lesker	CCG-xx-x	FCC68	3	AG-CM-ST R	none	CC
KJLC Cold Cathode Pirani	Lesker	CCPG-xx-x	FCC68	3	AG-CM-ST R	none	CCP
PVG-500 Pirani	Agilent	PVG500xxxxx	FCC68	3	AG-CM-ST R	none	PV5
PVG-550 Pirani	Agilent	PVG550xxxxxxx	FCC68	3	AG-CM-ST R	none	P55
IKR251 Cold Cathode	Pfeiffer	PT R25 500	Hirschmann	3	AG-CM-ST R	CM-HIR-S TR	ihp
FRG-700 Inverted	Agilent	FRG70xxxxx	FCC68	3	AG-CM-ST R	none	F70

Magnetron Pirani							
PCG-750 Pirani Capacitance Diaphragm Gauge	Agilent	PCG75xxxxxxx	FCC68	3	AG-CM-ST R	none	P75
PKR251 Inverted Magnetron Pirani	Pfeiffer	PT R26 000	Hirschmann	3	AG-CM-ST R	CM-HIR-S TR	P25
MPG400/401 Inverted Magnetron Pirani	Inficon	351-xxx	FCC68	3	AG-CM-ST R	none	IP4
PSG5xx ATM to Medium Vacuum Gauge	Inficon	350-xxx	FCC68	3	AG-CM-ST R	none	Pir
Gemini MAG500 Cold Cathode	Inficon	3MAx-xxx-x0xQ	FCC68	3	AG-CM-ST R	none	CC
Gemini MPG500 Cold Cathode Pirani	Inficon	3MBx-xxx-x0xP	FCC68	3	AG-CM-ST R	none	CCP
PCG550 Pirani Capacitance Diaphragm Gauge	Inficon	3PCx-01x-000x	FCC68	3	AG-CM-ST R	none	P75
MX4A Convection Gauge	Televac	all	DB15	3	AG-CM-ST R	AG-DB15- MX-STR	comin g soon
MX2A Thermocouple	Televac	all	DB15	3	AG-CM-ST R	AG-DB15- MX-STR	comin g soon
531 or 536 thermocouple vacuum gauge tube	Agilent	SEN-53x-xxxx	US-08	3	531-STR	none	TC
902B Absolute Piezo	MKS	902B-xx08x	FCC68	3	AG-CM-ST R	none	comin g soon

Sky Ambient Capacitance Manometer	Inficon	3xx-00x	DB15	3	AG-CM-ST R	CM-DB15 -STR	CM
Sky 45 Capacitance Manometer	Inficon	3CC1-x5xx30x	DB15	3	AG-CM-ST R	CM-DB15 -STR	CM
Sky 100 Capacitance Manometer	Inficon	3CD1-x5x-230x	DB15	3	AG-CM-ST R	CM-DB15 -STR	CM
Sky 200 Capacitance Manometer	Inficon	3CF1-x5x-2300	DB15	2	AG-CM-ST R	CM-DB15 -STR	CM
Stripe Capacitance Manometer	Inficon	3CC9-x5x-2380	DB15	3	AG-CM-ST R	CM-DB15 -STR	CM
626 Capacitance Manometer	MKS	626Cxxxxyz	DB15	3	CM-STR-D S	CM-DB15 -STR	CM
AA01A Capacitance Manometer	MKS	AA01AxxTxxx3x00 xxx	DB15	3	AG-CM-ST R	CM-DB15 -STR	CM
722B Capacitance Manometer	MKS	722BxxTxx2FA	DB9	3	AG-CM-ST R	CM-DB9- STR	CM
730B Capacitance Manometer	Setra	730G-xxxx-A-xx-2C -D9-X	DB9	3	AG-CM-ST R	CM-DB9- STR	CM
Porter Capacitance Manometer	Inficon	3CAx-x5x-0000	FCC68	3	AG-CM-ST R	none	CM
CDG500	Agilent	CDG500Txxxxxxxx	DB15	3	AG-CM-ST R	CM-DB15 -STR	CM
*note "x", "y", or "z" in part number means the part number can contain any option in that place							

Types of Active Gauges Supported

SVG-3 Name		Electrical Interface	Equation
PiR	PVG500 Pirani Active Gauge	FCC68 (RJ45)	$p = 10^{((V-c)/1.286)}$ $c=6.304$
CCP	MPG 500 Cold Cathode Pirani Active Gauge	FCC68 (RJ45)	$p = 10^{(1.667 \times V - d)}$ $d=11.46$
CC	MAG 500 Cold Cathode Active Gauges	FCC68 (RJ45)	$10^{(0.75 \times (V-c))}$ $c=12.826$

Sensor Options

SVG-3 Sensor ID	Gauge Name	Description
0.1	0.1 Torr ambient capacitance diaphragm gauge	0.1 Torr gas independent gauge for high accuracy measurement
1	1 Torr ambient capacitance diaphragm gauge	1 Torr gas independent gauge for high accuracy measurement
10	10 Torr ambient capacitance diaphragm gauge	10 Torr gas independent gauge for high accuracy measurement
100	100 Torr ambient capacitance diaphragm gauge	100 Torr gas independent gauge for high accuracy measurement
1,000	1,000 Torr ambient capacitance diaphragm gauge	1,000 Torr gas independent gauge for high accuracy measurement
CC	Cold Cathode Gauge	Cold cathode inverted magnetron high vacuum gauge
CCP	Cold Cathode + Pirani Combination Gauge	Combination cold cathode inverted magnetron Pirani gauge
PiR	Pirani Gauge	Advanced digital Pirani gauge with stainless steel sensor cell

Inficon SKY Capacitance Manometers supported

SVG-3 Sensor ID	Electrical Interface	Description	Equation
0.1	*DB-15	0.1 Torr gas independent gauge for high accuracy measurement	$P=V/100$
1	*DB-15	1 Torr gas independent gauge for high accuracy measurement	$P=V/10$
20	*DB-15	20 Torr gas independent gauge for high accuracy measurement	$P=2 \times V$
50	*DB-15	50 Torr gas independent gauge for high accuracy measurement	$P=5 \times V$
10	*DB-15	10 Torr gas independent gauge for high accuracy measurement	$P=V$

100	*DB-15	100 Torr gas independent gauge for high accuracy measurement	$P=V \times 10$
1,000	*DB-15	1,000 Torr gas independent gauge for high accuracy measurement	$P= V \times 100$

*Requires ADP-DB15-STRC Adaptor

Other Types of Active Gauges Supported

SVG-3 Name		Electrical Interface	Equation
523	***MKS 523C Cold Cathode Gauge	DB-9	$p = 10^{(2 \times V-8)}$
P25	MPG400/401 Cold Cathode Pirani Gauge	FCC68 (RJ45)	$p = 10^{(1.667 \times V-d)}$ d=11.46

***Support with ADP-DB9-523-STR Adaptor

MKS Capacitance Manometers supported

SVG-3 Sensor ID	Electrical Interface	Description	Equation
1	**DB-9	722B 1 Torr gas independent gauge for high accuracy measurement	$P=V/10$
20	**DB-9	722B 20 Torr gas independent gauge for high accuracy measurement	$P=2 \times V$
50	**DB-9	722B 50 Torr gas independent gauge for high accuracy measurement	$P=5 \times V$
10	**DB-9	722B 10 Torr gas independent gauge for high accuracy measurement	$P=V$
100	**DB-9	722B 100 Torr gas independent gauge for high accuracy measurement	$P=V \times 10$
1,000	**DB-9	722B 1,000 Torr gas independent gauge for high accuracy measurement	$P= V \times 100$
0.1	*DB-15	A-Baratron AA01 0.1 Torr gas independent gauge for high accuracy measurement	$P=V/100$
1	*DB-15	A-Baratron AA01 1 Torr gas independent gauge for high accuracy measurement	$P=V/10$
20	*DB-15	A-Baratron AA01 20 Torr gas independent gauge for high accuracy measurement	$P=2 \times V$
50	*DB-15	A-Baratron AA01 Torr gas independent gauge for high accuracy measurement	$P=5 \times V$

10	*DB-15	A-Baratron AA01 10 Torr gas independent gauge for high accuracy measurement	P=V
100	*DB-15	A-Baratron AA01 100 Torr gas independent gauge for high accuracy measurement	P=V x 10
1,000	*DB-15	A-Baratron AA01 1,000 Torr gas independent gauge for high accuracy measurement	P= V x 100

*Requires ADP-DB15-STR Adaptor

**Requires ADP-DB9-STR Adaptor

Specifications

Specifications	
Power:	100-240VAC 50/60 Hz CE Rated
Vacuum Interface:	1/8" Male NPT or KF/NW
Sensor: (length)	Dependent on sensor(s) installed
Range:	Dependent on sensor(s) installed
Units:	Torr, mBar, kPa
Mount	1/8" DIN or Bench Top
Display	0.40 inch high 6 digit red LED
Dimensions	1.7"H x 3.52"W x 5.35" Deep
Controls	7 amp, 250 Volt (If applicable)
Telemetry Options	USB, Wifi
Power Supply	24 Volt