



M108S TRIMMER

USER GUIDE v1.6



INTRODUCTION.....	3
SERVICES & REPAIRS.....	4
WARRANTY.....	5
SAFETY INSTRUCTIONS.....	6
GENERAL SAFETY PRECAUTIONS.....	7
GET TO KNOW YOUR MOBIUS M108S TRIMMER.....	9
AIRTHREAD TENSION TUMBLER.....	10
TRIFLEX BLADE SYSTEM.....	10
VARIABLE FUNCTION SYSTEM.....	11
WHAT'S IN THE CRATE?.....	11
INITIAL UNCRATING & INSPECTION.....	12
CRATE INSPECTION.....	12
UNPACKING & INSPECTION OF EQUIPMENT.....	12
MACHINE ASSEMBLY & DISASSEMBLY.....	13
SETTING UP TO OPERATE.....	14
PAIRING THE M108S TRIMMER WITH MOBIUS CONVEYORS.....	14
TANDEM SET-UP.....	16
PAIRING THE M108S TRIMMER WITH THE MOBIUS M9 SORTER.....	16
MOBIUS AUTOMATION SUITE CONFIGURATION EXAMPLES.....	17
OPERATION.....	18
MATERIAL PREPARATION.....	18
TRIMMER SET-UP.....	18
GENERAL OPERATION.....	19
HOT SWAPS.....	24
DRY TRIMMING: SINGLE M108S UNIT.....	25
DRY TRIMMING: TANDEM M108S SET-UP.....	26
WET TRIMMING: SINGLE M108S UNIT.....	27
WET TRIMMING: TANDEM M108S SET-UP.....	28
TIPS & TRICKS.....	29
CLEANING & MAINTENANCE.....	31
CLEANING.....	31
PREVENTATIVE MAINTENANCE.....	31
EXPECTED SERVICE LIFE OF STANDARD WEAR PARTS.....	32
OTHER INSTRUCTIONS & SUPPORT RESOURCES.....	33
INSTRUCTIONAL VIDEOS & GUIDES.....	33
MOBIUS OFFICE HOURS.....	33
GMP GUIDE.....	33
SUPPORT.....	33

PARTS ORDERS.....	33
TROUBLESHOOTING.....	34
SPECIFICATIONS.....	35
TECHNICAL SPECIFICATIONS.....	35
MATERIAL SPECIFICATIONS.....	35

INTRODUCTION

This User Guide is a comprehensive manual covering the operation and maintenance of the Mobius M108S Trimmer as of the date of publication. Eteros Technologies reserves the right to make updates to the machine from time to time. In the event of an update, this User Guide will remain applicable for the safe operation and maintenance of your unit. This User Guide, as well as any documentation supplied by component manufacturers, are to be considered the information package associated with this device. Every operator must read and understand the User Guide. The Guide should be located within easy access for periodic review.

SERVICES & REPAIRS

Repairs may only be carried out by Eteros Technologies or a designated authorized agent (service technician). Should the need arise, please notify us:

ETEROS TECHNOLOGIES

26 Industrial Ave.
Carleton Place, Ontario, Canada K7C 3T2
www.eteros.com
1.866.874.6244

Improper interfacing, improper repair, or unauthorized modification could result in void warranty claims.

WARRANTY

Thank you for purchasing Mobius Trimmer equipment from Eteros Technologies Inc.

The Mobius M108S Trimmer is covered by our manufacturer's warranty as follows:

- No warranty on consumable parts, including helical blades, spacer bars, bed knives, tumblers, fan housing filter bags, brushes, filters, and trim tote gaskets.;
- Warranty coverage for one (1) year or 1,000 operating hours, whichever occurs first, on motors, electrical components, and remainder of machine components.

The warranty period begins on the date the equipment is received by the customer. Any damage that occurs during shipping will be the responsibility of Eteros Technologies.

The above terms are valid if Mobius equipment is used and maintained as directed. If the equipment is modified in any way, all terms of this warranty are void. This warranty does not apply to cosmetic damage, such as scratches or general wear and tear.

Should you experience a technical problem with your equipment, please contact Eteros Technologies at the email or phone number outlined in the [Services & Repairs](#) section.

Tumbler, helical blade and bed knife damage is very rare on a MOBIUS M108S and is typically the result of foreign objects or poor setup. Damage resulting from foreign objects entering the trimmer or poor setup is not covered under warranty. In the event of damage, please contact ETEROS TECHNOLOGIES for assessment. Repair and part replacements must be completed by ETEROS TECHNOLOGIES or an authorized agent. To avoid damage, please take care to properly maintain the MOBIUS M108S and do not let foreign objects enter the trimmer.

SAFETY INSTRUCTIONS

To ensure operator safety while in use, this device includes decals, guarding, and other safety features. Operators are encouraged to use caution and best judgment when using equipment. Equipment should be serviced when required.

To avoid possible damage to the machine and risk of injury to the operator, consult with an Eteros Technologies representative to answer any questions.

All operators must read and understand this User Guide and be trained in safe operation and use of the machine. We recommend the owner of this equipment develop a standard operating procedure (SOP) specific to each worksite to address any local hazards or other conditions not outlined in this User Guide. The machine must be inspected regularly for damage, component failure, and wear. Results of inspection activity should be documented.

Eteros Technologies makes every effort to ensure the machine is compliant with all current safety standards. It is the responsibility of the owner to ensure all municipal, provincial, state, county, territorial, and federal codes, regulations, and standards have been met in each working location.

Do not lend or rent your machine without providing the User Guide. A first-time operator should receive practical instruction before using the machine.

This machine is not to be used for any purpose other than those expressly stated in the User Guide, advertising literature, or other Eteros Technologies written material pertaining to the machine.

GENERAL SAFETY PRECAUTIONS

KNOW THE SAFETY INFORMATION

Read and become familiar with the entire User Guide. Learn the equipment applications, limitations, and possible hazards.

KEEP GUARDS AND SHIELDS IN PLACE

Keep all guarding in place and in working order to protect both the device and the operator.

WORK IN A SAFE ENVIRONMENT

Do not use equipment in a dangerous environment or damp/wet locations. Never expose the control panel directly to rain or water. Keep the work area well-illuminated.

WORK AWAY FROM FLAMMABLE LIQUIDS OR GASES

Do not use the device in the presence of flammable liquids or gases.

KEEP THE WORK AREA CLEAN

Cluttered areas and workspaces invite accidents.

TRAINED OPERATORS ONLY

Keep children and bystanders away from the device. visitors should be kept at a safe distance from the work area.

DON'T FORCE THE EQUIPMENT

It will operate optimally and safely at the rate for which it was designed.

USE THE RIGHT TOOL

Don't force the device to do a job for which it was not designed.

WEAR PROPER APPAREL

Do not wear loose clothing, gloves, neckties, rings, bracelets, or other jewelry that may get caught in moving parts. Non-slip footwear is recommended. Wear a protective hair covering to contain long hair.

ALWAYS OPERATE DEVICE IN A WELL-VENTILATED AREA

Dust generated from certain materials can be a health hazard. Use a dust collection system whenever possible.

WEAR A FACE MASK OR DUST MASK

This device may produce dust or operate near other dust-producing machines. If dust extraction is not considered, a dust mask must be worn.

POWER DOWN AND DISCONNECT

Power down and disconnect equipment before servicing and when changing any accessories, consumables, or other components.

CHECK FOR DAMAGED PARTS BEFORE OPERATION

The equipment should be inspected prior to use to ensure proper operation in performing its intended function. Check for alignment of moving parts, binding of moving parts, breakage of parts, mounting, and any other conditions that may affect its operation. Any damaged part including guards should be properly repaired or replaced.

ALWAYS WEAR EYE PROTECTION

Safety goggles can protect your eyes from fast-moving debris.

ALWAYS WEAR EAR PROTECTION

Wear ear muffs or earplugs when operating loud machinery.

GET TO KNOW YOUR MOBIUS M108S TRIMMER

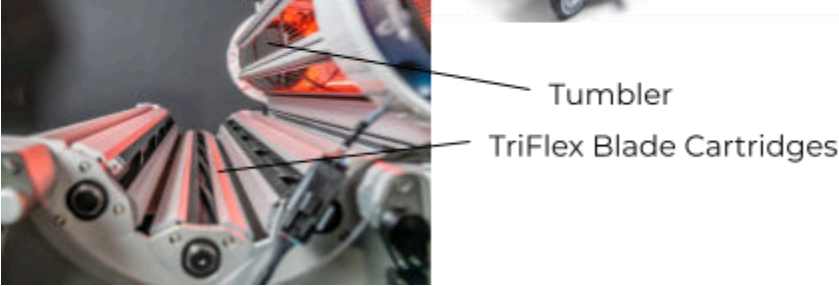

AIRTHREAD TENSION TUMBLER

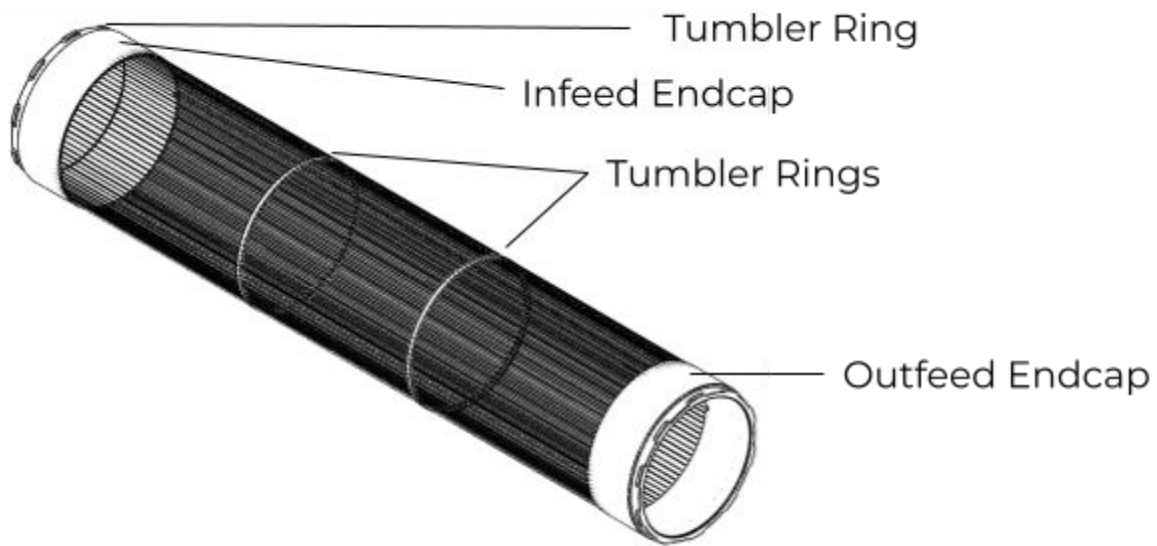

TRIFLEX BLADE SYSTEM

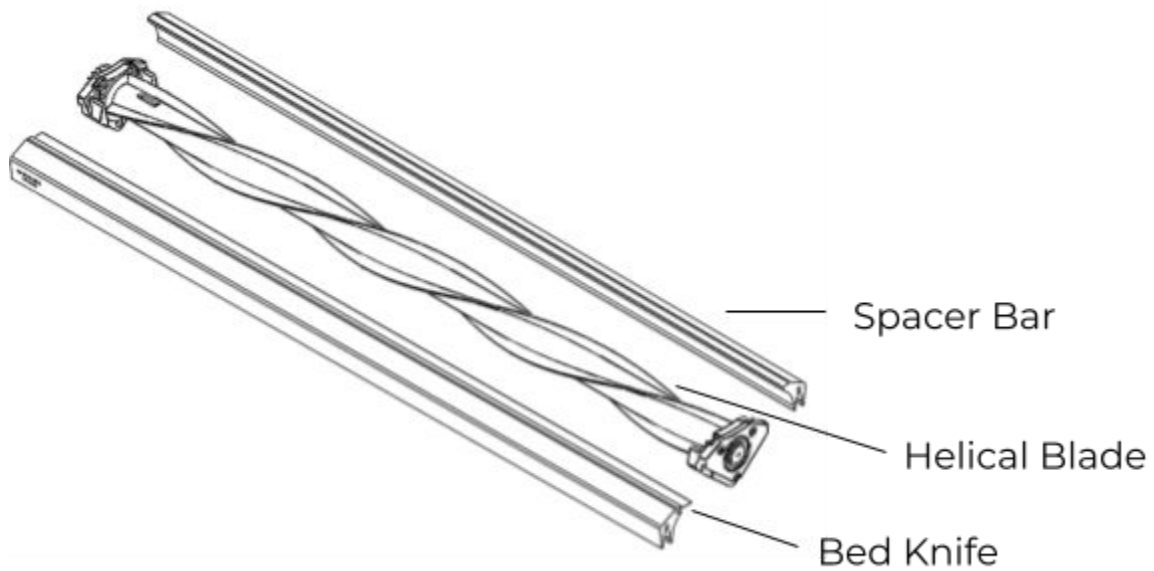

VARIABLE FUNCTION SYSTEM



WHAT'S IN THE CRATE?

Your M108S Trimmer arrives with the following components:

INSTALLED ON MACHINE		PACKED SEPARATE FROM MACHINE	
3	Helical Blade	1	15' Power Cord
3	Bed Knife	2	Tumbler
3	Spacer Bar	2	Trim Tote with Gasket
2	Sensor Override Pucks	2	E-box Filter
2	Tandem Locks	2	Dry Trim Exhaust Filter
1	Brush	1	Wet Trim Exhaust Filter
1	E-Box Filter	1	Filter Bag Wire
1	Spare Drive Belt	1	Spring Jack
		1	Infeed Hopper
		1	Outfeed Chute
		2	Tumbler Retaining Ring
		1	Instructional Poster Package

INITIAL UNCRATING & INSPECTION

CRATE INSPECTION

Inspect the exterior of the crate for any damage that may have been caused during shipping. If there is visible damage that may be indicative of damage to the contents, take photos of the damage and contact Eteros Technologies for further instructions.

UNPACKING & INSPECTION OF EQUIPMENT

Inside the machine crate is the fully-assembled Mobius M108S Trimmer, fastened to the crate base, and separately packaged accessory items.

A detailed instructional video for unpacking the crate is available at mobiustrimmer.com/uncrate-m108s/

Once the trimmer and all of the accessories are unpacked, ensure that all items are accounted for and in good condition. (See 'WHAT'S IN THE CRATE?' on the previous page)

MACHINE ASSEMBLY & DISASSEMBLY

Assembly and disassembly of the trimmer will be required to clean the equipment and to carry out periodic maintenance activities.

The following videos provide detailed instructions on how to install and remove key components on the M108S Trimmer. (Find all instructional videos at mobiustrimmer.com/instructions/)

SEPARATOR INSTALLATION

BLADE CARTRIDGE REMOVAL & INSTALLATION

LID REMOVAL & INSTALLATION

TUMBLER INSTALLATION & REMOVAL

ELECTRICAL BOX (E-BOX) FILTER REMOVAL & INSTALLATION

SETTING UP TO OPERATE

The M108S Trimmer can be operated as a single unit, manually fed using the infeed hopper that comes included with the machine, or it can be operated as part of a larger automation line for high-volume trimming and sorting. The following sections describe how to pair other equipment with the Mobius Trimmer.

PAIRING THE M108S TRIMMER WITH MOBIUS CONVEYORS

To get the most out of your Mobius Trimmer, consider pairing it with an Infeed Conveyor and an Outfeed Conveyor.

Pairing the M108S with an Infeed Conveyor instead of manually feeding it using a hopper offers the following benefits:

- Higher throughputs;
- More consistent trimming results;
- Opportunity to remove foreign objects (i.e. pieces of lattice, zip ties, gloves, etc.) before they run through the trimmer with your product; and
- Ability to pull out excess water leaves, which boosts both throughputs and trim potency.

Adding an Outfeed Conveyor instead of having your trimmed flower simply fall into a collection bin offers the following benefits:

- Real-time quality control (QC) of trimmed product;
- Ability to monitor and, if necessary, adjust trimmer settings to dial in finished product; and
- Ability to easily weigh and batch product as it comes out of the trimmer.

[Mobius Conveyors](#) have been designed specifically to integrate with the M108S Trimmer. To pair the Mobius Infeed Conveyor to the M108S Trimmer, install the infeed guide plate on the trimmer and then hook the belt tensioning stubs on the conveyor frame into the hooks on the guide plate. As the trimmer is raised and lowered during operation, the guide plate will ensure that the Infeed Conveyor stays connected to the trimmer and moves up and down with it.



To pair the Mobius Outfeed Conveyor to the M108S Trimmer, simply roll the conveyor into place, either inline with the trimmer or at a right angle, in either direction.



TANDEM SET-UP

If your operation is looking to process larger volumes or simply wants to increase its hourly trimming throughput, connecting two Mobius M108S Trimmers in tandem is the answer.

A how-to video for connecting two M108S units in tandem is available at: mobiustrimmer.com/instructions/m108s-trimmer-tandem-setup/



PAIRING THE M108S TRIMMER WITH THE MOBIUS M9 SORTER

Mobius equipment is designed to be modular and one of the options that really helps drive automated processing operations is the Mobius M9 Sorter. When set up as an automated trimming and sorting line, the Mobius M9 Autofeed Conveyor connects the two machines so that product can flow continuously and seamlessly from the M108S Trimmer to the M9 Sorter.

Note: The line can be configured with or without the Mobius Outfeed Conveyor and each piece can be set up either inline or at right angles. Below are some of the configuration options.

MOBIUS AUTOMATION SUITE CONFIGURATION EXAMPLES

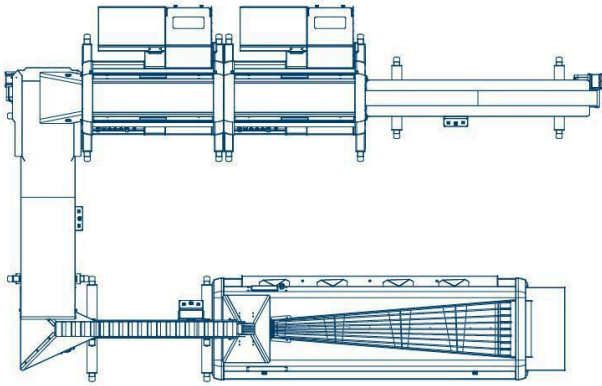
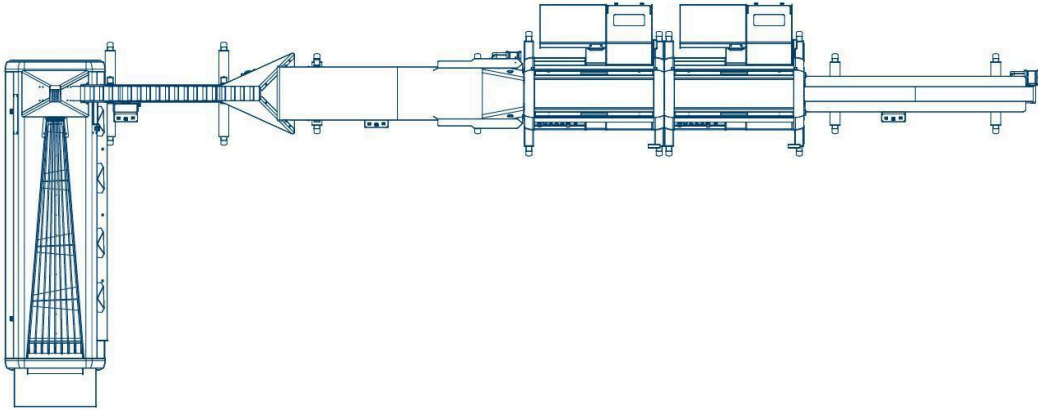
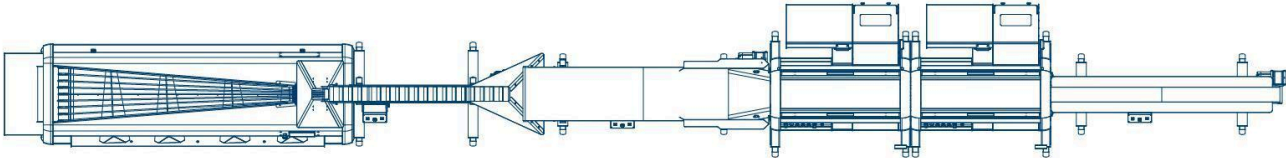

OPERATION

MATERIAL PREPARATION

The M180S Trimmer can be used to trim wet (fresh) or dry material. If trimming dry, it is recommended that the material have a moisture content in the range of 11% - 15%. When the moisture content is below 11%, the material tends to become very brittle and fragile and the flower-to-trim ratio suffers as a result.

TRIMMER SET-UP

Take the following steps to set up the trimmer for operation:

1. Ensure there is sufficient space in the operating area to accommodate the following:
 - Allow for enough space behind the machine to comfortably install and remove the trim tote.
 - Allow for enough space at the front of the machine to allow the operator to easily access the control panel and, in particular, the emergency stop button.
 - Allow for enough space on the infeed of the trimmer to accommodate either the infeed hopper or an Infeed Conveyor.
 - Allow for enough space around the infeed to have multiple totes of material staged and ergonomically positioned to feed into the trimmer.
 - Allow for enough space on the outfeed to accommodate collection totes, an outfeed conveyor, sorting equipment, scales, or any other equipment necessary to maintain a consistent processing workflow.
 - If using an Outfeed Conveyor to perform quality control functions, allow for enough space to position personnel safely and comfortably on one or both sides of the conveyor.
 - Consider the proximity of the trimmer to the power source. The standard power cord supplied with the M108S Trimmer is 15' (4.5m). For custom cord lengths, please contact Eteros Technologies.
2. Check that the electrical box filter is in place and clean. It is recommended that the electrical box filter is replaced after every trim session.
3. Check that the correct exhaust filter (wet trimming filter versus dry trimming filter) is in place and clean. It is particularly important that the dry trimming exhaust filter

is not clogged. If air cannot easily flow through the filter, the strength of the vacuum created by the machine is diminished and trim quality will suffer.

4. Confirm that the power cord is in good condition and that the twist lock plug ends are locked into the machine power receptacle and the power source.
5. Ensure all guarding is properly installed on the trimmer and on any other accessories and/or machines being used in conjunction with the trimmer.
6. Ensure that the tumbler and all blade components are in good condition and properly installed in the machine. Carry out the [6-Point Blade Inspection](#) before starting the machine.
7. Ensure that the [separator is properly assembled](#) and installed and that the trim tote(s) and gasket(s) that will be going into operation are in good condition and properly installed.
8. Address any errors that are flagged on the control panel.

GENERAL OPERATION

PRIOR TO DEVICE OPERATION, ENSURE ALL GUARDS ARE IN PLACE AND PROPERLY SECURED. PRESS THE E-STOP BUTTON AT ANY TIME TO STOP ALL MOVING PARTS AND TURN OFF THE MACHINE.

GETTING READY TO TRIM

1. Identify a Trim Team Lead. This person is responsible for:
 - Ensuring that the trimmer is set up correctly and all pre-start inspections have taken place;
 - Ensuring that appropriate PPE is available and utilized by all team members in the room;
 - Assigning trim team roles, as per item 2 below;
 - Operating the trimmer and dialing in the key variables (feed rate, tilt angle, tumbler speed, vacuum, and blades) until the desired level of trim is reached on the outfeed.

Note: There is a delay between making a change to one or more of these variables and seeing the impact of that change on the buds coming out of the trimmer. Be patient when dialing in the trimmer settings so as not to over-correct.

2. Identify roles for each of the trim team members. Typical roles could include:
 - Feeding the trimmer via the Infeed Conveyor or infeed hopper;
 - Performing QC and polishing of material on the Outfeed Conveyor or outfeed collection tote;
 - Acting as a runner, which includes bringing totes of untrimmed material to the infeed line, changing out full totes for empty totes on the outfeed line, keeping an eye on and swapping out the trim tote when full, weighing material, as required, etc.

Note: For a more comprehensive description of these and related roles check out our blog article, *How to Staff a Mobius Cannabis Processing Line*.
mobiustrimmer.com/how-to-staff-a-mobius-trim-line/

3. Put the infeed and outfeed equipment into place. If using conveyors, ensure they are adjusted to the correct height. For the Outfeed Conveyor, this means setting it at a height below the outfeed of the trimmer. For the Infeed Conveyor, this means setting it at a height that has the belt just touching the Infeed Conveyor guide when the tilt angle is at the lowest level you will be operating at. It is ok if the lead legs on the Infeed Conveyor lift off the floor when the tilt angle is increased.
4. Ensure the trim tote is properly installed.
5. Ensure there is an adequate amount of bucked material available at the infeed end of the trim line and that is within easy reach of the operator who will be feeding the machine.
6. Ensure there is an empty tote on the outfeed end of the trim line to collect the material.
7. Fill the Infeed Conveyor belt or hopper with material in preparation for beginning trimming operations.

MACHINE START-UP SEQUENCE

1. Disengage the e-stop button.
2. Press the blue button to turn on the machine. The lights will turn from blue to white indicating the machine is ready to begin trimming.

3. Pull out each of the three buttons that control the VFDs (blades, vacuum, tumbler) and turn the dials to the maximum level (11).

TRIMMING – GENERAL

1. The Mobius M108S performs best when the tumbler is relatively full. Depending on the material, aim to keep the tumbler approximately 65% – 75% full when dry trimming and approximately 50% – 65% full when wet trimming. We call this 'priming' the tumbler. This means that you will be filling the tumbler relatively quickly upon start-up and then backing that off to your regular feed rate once the tumbler is primed. See below for more details on specific trimming scenarios.
2. Proper functioning of the vacuum system is critical to overall performance of the M108S. Always ensure that the separator is properly assembled and that the trim tote gasket is in good condition and flush with the separator upon installation. Any breach of the vacuum system will negatively impact trim quality and throughput and will direct plant material through the impeller and fan housing exhaust.
3. To achieve consistent results, the material being fed into the machine must be consistent. To the degree possible, ensure that all totes of untrimmed material have been prepared to a relatively consistent level (i.e. same amount of fan leaves present, same degree of breakdown of larger flower clusters, etc.).
4. To achieve consistent trimming results, the feed rate to the machine must be consistent. Once the tumbler is filled to the correct capacity and you have dialed in the quality of trim you are seeking, aim to maintain a consistent feed rate for the remainder of the trim session.

If you are using a conveyor to feed the machine, we recommend filling the conveyor belt with a single even layer of plant material. Training operators to use the Infeed Conveyor in this way will ensure consistency between operators and make the speed dial on the conveyor a meaningful trimming parameter.

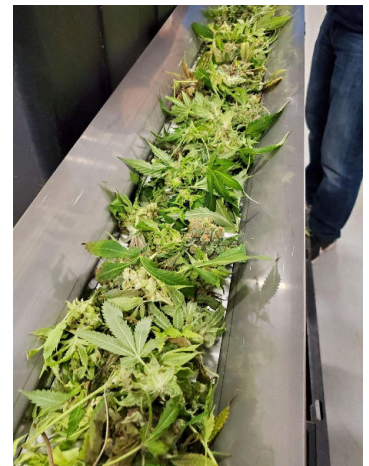

5. Assuming that the material has been consistently prepared, there are four key factors that the operator can use to adjust trim quality:

TILT ANGLE

Increasing the tilt angle uses gravity to move the material through the tumbler more quickly. The higher the tilt angle, the less time the buds spend in the tumbler and the looser the trim. The lower the tilt angle, the more time the buds spend in the tumbler and the tighter the trim.

- Dry Trimming: Tilt angle will vary from flat to maximum tilt

- Wet Trimming: Tilt angle will vary from flat to maximum tilt

FEED RATE

Increasing the feed rate to the machine will move (push) material through the tumbler more quickly. The faster the feed rate, the looser the trim. The slower the feed rate, the tighter the trim.

- Dry Trimming: Feed rate will vary depending on material and amount of leaf to be trimmed
- Wet Trimming: Feed rate will vary depending on material and amount of leaf to be trimmed

TUMBLER SPEED

Adjusting the tumbler speed, especially when trimming dry, will help ensure that all of the buds have access to the blades. Faster tumbler speeds are appropriate when the material is particularly dense or heavy (i.e. wet trimming). When the material is lighter or less dense (i.e. dry trimming), slower tumbler speeds will allow for the buds to mix in the tumbler so that there is even access to the blades.

- Dry Trimming: Tumbler speed will likely be in the range of 3 – 8
- Wet Trimming: Tumbler speed will be at maximum

VACUUM

Vacuum dictates how tightly the material in the tumbler is pulled towards the blades and how long the material spends in the tumbler. Reducing the vacuum will allow material to flow through the tumbler quicker with a looser trim; increasing the vacuum holds the material in the tumbler longer and tightens the trim.

- Dry Trimming: Vacuum will be at maximum for most runs. Only with particularly light, larfy material will the vacuum be reduced.
- Wet Trimming: Vacuum will be at maximum

6. Once the desired trim quality has been dialed in, the job of the resources on the outfeed is to perform QC on the material. The specific criteria to look for are established by the end user and could include things like bud size or mold, but with respect to trimming, it is generally crow's feet that the QC line is on the lookout for. As a general rule of thumb, a bud that requires 2 – 3 snips to clean up should get addressed on the outfeed line; a bud that requires more than that should be set aside in a separate bin for clean-up off of the outfeed line or run through the machine a second time. If more than 5% of material is being set aside like this, consider adjusting the machine parameters to tighten up the trim.

TUMBLER EMPTY SEQUENCE

At the end of a batch or trim session, there is no longer material being fed into the infeed end of the trimmer to push material through to the outfeed. To ensure that the material at the end of a batch is properly trimmed and exits the tumbler without being over-trimmed, follow these steps:

1. Once the last of the material has been loaded into the tumbler, begin to slowly raise the tilt angle of the machine.
2. Slowly ramp down the vacuum over a period of approximately one to two minutes and then shut off the vacuum and the blades. Leave the tumbler running. If operating in tandem, perform this step on the infeed machine first and then perform this same step on the outfeed machine.
3. Continue running the tumbler until all of the material has exited the machine.

TRIM TOTE CHANGES

Depending on the material being run, the trim tote may fill up every 15 – 25 minutes. Below are the steps to take when changing out the trim tote:

1. Ensure that one of the trim team resources in the room is assigned to monitor the trim tote fill level and stop the line when it is time to empty it out.

Note: If the trim tote is allowed to overflow, trimmed material will be forced to bypass the tote and get directed into the impeller and fan housing exhaust. Always empty the trim tote prior to it becoming completely full.

2. When the trim tote is ready to change out, stop the Infeed Conveyor (if using), turn off the blades, vacuum, and tumbler by pressing the dials on the control panel, and activate the e-stop switch.
3. Once the trimmer is at a full stop, disengage the trim tote lock levers and pull out the full trim tote.
4. Install an empty trim tote into the separator and engage the trim tote lock levers. Ensure that the trim tote is properly seated and that the trim tote gasket is fully sealed against the separator.
5. To recommence trimming operations, turn on the vacuum first and wait until it gets up to full speed (approximately 5 seconds) before turning on the tumbler and

blades. This will hold the material in the tumbler and prevent it from spilling out the end in a big batch during start-up.

6. Once the vacuum has ramped up to full power (approximately 5 seconds), turn on the blades, tumbler, and, if using them, the Infeed and Outfeed Conveyors.

HOT SWAPS

The Mobius M108S was designed in a way that enables speedy swap-out of all plant-touching components. Depending on the material being run (wet, dry, strain, etc.), the temperature in the room, and a variety of other factors, some or all of these plant-touching parts may need to be changed out during a trim session. We call this a 'hot swap'.

Wet trimming a very sticky strain in a warm room may require performing a hot swap after only 90 minutes, while dry trimming in a cool room might not require a hot swap at all, even after six hours. Under normal operating conditions, hot swaps are typically performed every 2 – 5 hours during trimming.

To perform a hot swap, take the following steps:

1. Ensure that one of the trim team resources in the room is assigned to keep an eye out for when it is time to perform a hot swap.
2. When it's time for a hot swap, stop the conveyors (if using them), turn off the blades, vacuum, and tumbler by pressing the dials on the control panel, and activate the e-stop switch.
3. Open the lid of the machine to inspect the tumbler, brush, bed knives, spacer bars, and helical blades. Determine what parts require swap-out:
 - Resin tends to build up fastest on the bed knives, so these will likely be changed on every hot swap.
 - If wet trimming, it is a good idea to keep the brush clean. Either swap in a new brush or remove the one in use, run a hand up and down the brush to clear off any plant material stuck in the bristles and reinstall it in the lid.
 - Tumbler, spacer bars, and helical blades may or may not need to be swapped out. Assess resin build-up and swap out these parts as necessary.
 - Since the machine is already at a stop, it is usually a good idea to empty or swap out the trim tote at this time as well.

4. Once the hot swap is complete, close the lid and perform the **6-Point Blade Inspection**. Because the machine has been in operation, it is possible for small pieces of plant material to interfere with how the blade cartridge components are seated. Use the 6-Point Blade Inspection (From both ends check that the points of all three bed knives are the same distance from the tumbler) to ensure all components are correctly seated.

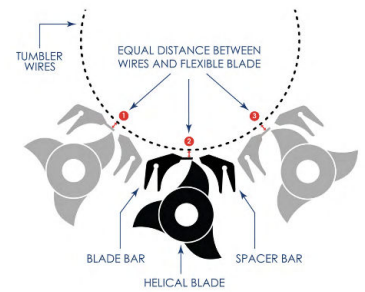

5. To recommence trimming operations, turn on the vacuum first. This will hold the material in the tumbler and prevent it from spilling out the end in a big batch during start-up.
6. Once the vacuum has ramped up to full power (approximately 5 seconds), turn on the blades, tumbler, and, if using them, the Infeed and Outfeed Conveyors.

DRY TRIMMING: SINGLE M108S UNIT

When dry trimming with a single M108S Trimmer, try starting with the following parameters and adjust as necessary to reach the desired trim quality:

VFDs

Blades: At full power (11)

Vacuum: At full power (11). If the structure of the material is very open, light, and larfy, consider lowering the vacuum to allow for the buds to move more freely through the tumbler (in the range of 5 – 9).

Tumbler: Start in the range of 5 – 7 and adjust as necessary.

TUMBLER FILL

'Priming' the tumbler is critical for dry trimming. Priming the tumbler means filling it as rapidly as possible to 65% - 75% full. Once the tumbler is 65% - 75% full, lower the conveyor speed or the speed of the manual feed to maintain a consistent fill level in the tumbler.

Because it can be difficult to tell how full the tumbler is when it is spinning, observe how much of the blades are covered by plant material. When the tumbler is properly filled, the two blades towards the front of the machine will be completely covered and most of the back blade, save the 4 to 10 inches closest to the infeed, will also be covered. The tumbler fill level will taper off in a similar way at the outfeed.

TILT ANGLE

Start with casters at the infeed end of the line approximately 1" off the floor. After the tumbler has been primed and the feed rate has been dialed in for trim quality, adjust the tilt angle up or down to maintain the tumbler at 65% - 75% full.

FEED RATE

As the tilt angle is adjusted the feed rate will also need to be adjusted to maintain the 65% - 75% fill level in the tumbler. If the tilt angle is increased, the feed rate will also increase. If the tilt angle is decreased, the feed rate will also decrease.

DRY TRIMMING: TANDEM M108S SET-UP

When dry trimming with a tandem Mobius line, try starting with the following parameters and adjust as necessary to reach the desired trim quality:

VFDs

Blades – both machines: At full power (11)

Vacuum – both machines: At full power (11). If the structure of the material is very open, light, and larfy, consider lowering the vacuum of both machines to allow for the buds to move more freely through the tumblers (in the range of 5 – 9). Alternatively, a single trimmer can be used for very delicate, underdeveloped batches of material.

Tumbler – both machines: Start in the range of 5 – 7 and adjust as necessary.

TUMBLER FILL

'Priming' the tumblers is critical for dry trimming. Priming the tumblers in tandem means filling the first tumbler and approximately half of the second tumbler as rapidly as possible to 65% - 75% full. Once the tumblers are 65% - 75% full, lower the conveyor speed or the speed of the manual feed to maintain a consistent fill level in the tumblers over the two machines.

Because it can be difficult to tell how full the tumblers are when they are spinning, observe how much of the blades are covered by plant material. When the first tumbler is properly filled, the two blades towards the front of the machine will be completely covered and most of the back blade, save the 4 to 10 inches closest to the infeed, will also be covered. The fill level of the second tumbler will taper off in a similar way at the outfeed.

TILT ANGLE

Start with casters at the infeed end of the line approximately 3" off the floor. After the tumblers have been primed and the feed rate has been dialed in for trim quality, adjust the tilt angle up or down to maintain the tumblers at 65% - 75% full.

FEED RATE

As the tilt angle is adjusted the feed rate will also need to be adjusted to maintain the 65% - 75% fill level in the tumblers. If the tilt angle is increased, the feed rate will also increase. If the tilt angle is decreased, the feed rate will also decrease.

WET TRIMMING: SINGLE M108S UNIT

When wet trimming with a single M108S Trimmer, try starting with the following parameters and adjust as necessary to reach the desired trim quality:

VFDs

Blades: At full power (11)

Vacuum: At full power (11)

Tumbler: At full power (11)

TUMBLER FILL

When wet trimming, there is no need to rapidly prime the tumbler (unlike dry trimming) but it is important to maintain the tumbler at approximately 50% – 65% full.

Because it can be difficult to tell how full the tumbler is when it is spinning, observe how much of the blades are covered by plant material. When the tumbler is properly filled, the two blades towards the front of the machine will be completely covered and most of the back blade, save the 6 to 12 inches closest to the infeed, will also be covered. The tumbler fill level will taper off in a similar way at the outfeed.

TILT ANGLE

Start with casters at the infeed end of the line approximately 1" off the floor. After the tumbler has been primed and the feed rate has been dialed in for trim quality, adjust the tilt angle up or down to maintain the tumbler at 50% - 65% full.

FEED RATE

As the tilt angle is adjusted the feed rate will also need to be adjusted to maintain the 50% - 65% fill level in the tumbler. If the tilt angle is increased, the feed rate will also increase. If the tilt angle is decreased, the feed rate will also decrease.

WET TRIMMING: TANDEM M108S SET-UP

When wet trimming with a tandem Mobius line, try starting with the following parameters and adjust as necessary to reach the desired trim quality:

VFDs

Blades: At full power (11)

Vacuum: At full power (11)

Tumbler: At full power (11)

TUMBLER FILL

When wet trimming, there is no need to rapidly prime the tumblers (unlike dry trimming) but it is important to maintain the tumblers at approximately 50% – 65% full.

Because it can be difficult to tell how full the tumblers are when they are spinning, observe how much of the blades are covered by plant material. When the first tumbler is properly filled, the two blades towards the front of the machine will be completely covered and most of the back blade, save the 6 to 12 inches closest to the infeed, will also be covered. The fill level of the second tumbler will taper off in a similar way at the outfeed.

TILT ANGLE

Start with casters at the infeed end of the line approximately 3" off the floor. After the tumblers have been primed and the feed rate has been dialed in for trim quality, adjust the tilt angle up or down to maintain the tumblers at 50% - 65% full.

FEED RATE

As the tilt angle is adjusted the feed rate will also need to be adjusted to maintain the 50% - 65% fill level in the tumblers. If the tilt angle is increased, the feed rate will also increase. If the tilt angle is decreased, the feed rate will also decrease.

TIPS & TRICKS

Our team has visited countless facilities all over the world since the release of the Mobius Trimmer and we've learned a lot along the way! Here are the tips & tricks that we use to maximize trimming throughput and quality.

- If dry trimming, aim to have the moisture content of the material in the 11% - 15% range. When the moisture content is lower than 11% the leaves tend to curl into the flower, making it harder to remove the leaf without also shaving away some of the flower. It also makes the plant material more brittle, causing the leaves to break off, instead of being cleanly sheared off.
- Related to the first point, be careful about rehydrating. If your plant material was dried down to 8% and you've rehydrated it back up to 13%, there's a chance that the structure of the leaves and stems has been compromised, making it difficult to achieve a clean trim. If you find yourself in this situation, try rehydrating a small batch first and see if you are able to cleanly pinch off leaves and stems. If so, go ahead with rehydrating to that level. If not, you may want to consider rehydrating to a lower level or moving forward with trimming the material as-is.
- Denser buds, regardless of shape or size, trim up better than light, larfy buds. Consider adding bud density to your list of factors that are assessed when choosing which strains to cultivate.
- The Mobius Trimmer can handle pretty much anything you can throw at it, but what you get out is directly related to what you put in. If you feed material that has been very well prepared, with all of the larger leaves removed, you can expect to perform less clean-up on the outfeed and to achieve a high flower-to-trim ratio. On the other hand, if the material has not been broken down and a high proportion of the material is larger leaves and stems, you can expect to require more clean-up of crow's feet and a much lower ratio of flower to trim.
- Keep your plant material and your trim room as cool as possible. This will better maintain the condition of the buds and reduce resin build-up on the machine components, hence extending the time between hot swaps. Users should aim to keep their trim environment at 18°C/64°F or lower. The M108S can be operated in a very wide temperature range, so the limiting factor is generally the facility infrastructure.
- Related to the point above, consider keeping a spray bottle filled with ice water on hand if you are wet trimming. Giving the tumbler a spritz through the lid screens every 5 – 10 minutes can help reduce resin build-up.

Note: The M108S does not require lubrication – this is simply for the purpose of reducing resin build-up on the blades and tumbler.

- To achieve peak throughputs and consistent trim quality, the following functions should be added to the duties of the Trim Team Lead (or other resource):
 - The Infeed Conveyor must always be loaded with material, and the loading must be done correctly (i.e. in a single, consistent layer);
 - The amount of time that there is a red light in the lid must be minimized. Brief stops for trim tote changes and hot swaps should be the only reason the machine is not running. If the lid is red, the Trim Team should be immediately on it with the goal of getting up and running again as quickly as possible.
 - The following must be on-hand at all times so as to prevent unnecessary stoppages (see previous bullet):
 - Spare trim totes placed near the back of the trimmer for quick swap-out
 - Empty collection bins placed near the outfeed line for quick swap-out
 - Full bins of material placed near the infeed line so that the Infeed Conveyor is always full and has a continuous supply of untrimmed product
- At the beginning of a trim session, the material that comes out of the machine in the first minute or two will not necessarily be trimmed to the level being sought, since the tumbler is just getting filled and the tilt angle and feed rate are getting dialed in. To best manage this, Eteros recommends having two totes available on the outfeed. Over the first few minutes, material is collected in Tote A on the outfeed; once the desired level of trim is reached, swap in Tote B on the outfeed. The material in Tote A can then be run through the trimmer again or set aside for touch-up by hand.
- In general, our observation is that it is faster overall to spend the time on preparing material upstream of trimming, and this will always yield a higher value (i.e. higher cannabinoid content) trim. Some operations are not structured in a way that allows for this, which is no problem, but the end-user must adjust their throughput and yield forecasts accordingly.

CLEANING & MAINTENANCE

CLEANING

Keeping your trimmer clean is the best preventative maintenance action you can take to keep it in peak operating condition and maximize its service life.

To help design an effective and efficient cleaning program, we strongly recommend all users review the following when getting started:

- [The Fundamentals of Equipment Cleaning](#)
- [Mobius Webinar Series - how to set up a cleaning program for your cannabis harvesting equipment](#)

Detailed cleaning instructions for the M108S Trimmer, broken down component by component, are outlined on the Mobius website at mobiustrimmer.com/instructions/recommended-cleaning-procedures/.

PREVENTATIVE MAINTENANCE

Detailed preventative maintenance instructions for the M108S Trimmer are available on the Mobius website at mobiustrimmer.com/instructions/preventative-maintenance/.

We also recommend performing a parts inventory and detailed inspection at least once per month. A parts inspection checklist is available at mobiustrimmer.com/instructions/monthly-parts-inspection-checklist/.

Additional instructional guides for the M108S Trimmer can be found at mobiustrimmer.com/instructions/#m108s.

EXPECTED SERVICE LIFE OF STANDARD WEAR PARTS

The table below provides an estimate of the expected service life of the standard wear parts on the M108S Trimmer. These estimates are provided for planning purposes and are an approximation only. How the trimmer is cleaned and maintained will impact the actual number of hours a part can be put into service.

PART	EXPECTED SERVICE LIFE
E-box Filter	Replace prior to each trim session
Exhaust Filter – Dry Trim	10 hours
Exhaust Filter – Wet Trim	200 hours
Bed Knives	200 hours
Brush	200 hours
Tumbler	200 hours
Trim Tote & Gasket	Inspect prior to each use and replace as necessary
Spacer Bars	1,000 hours
Helical Blades	1,000 hours
Drive Belt	1,000 hours
Pulleys, Gears, and Bearings	1,000 hours
Lid Bearings	Lid serviced with new bearings at 1,000 hours

Based on these numbers, the operating cost of the M108S Trimmer is approximately \$20 - \$25 per hour.

POWER CORD SET INFORMATION

CAUTION Risk of fire and electric shock. Use only with the original equipment manufacturer's power cord set. The recommended replacement M108S Power Cord (SKU 00-01-001781) can be purchased at mobiustrimmer.com/product/m108s-power-cord/.

Need to order parts?

Most replacement parts can be found on the online Mobius store at <https://mobiustrimmer.com/replacement-parts/> or feel free to email us at orders@mobiustrimmer.com or call us at 1-866-874-6244 to place your order.

OTHER INSTRUCTIONS & SUPPORT RESOURCES

INSTRUCTIONAL VIDEOS & GUIDES

This User Guide provides a general overview of the set-up, operation, and maintenance of the M108S Trimmer. For more in-depth instructions for particular assembly, operation, and maintenance steps, please visit <https://mobiustrimmer.com/instructions/#m108s>.

You may also find a number of the [Mobius Blog Posts](#) or the [Mobius Webinar Series](#) to be helpful.

MOBIUS OFFICE HOURS

Have a question that you want to run by us or want to connect with other Mobius users? Check out the weekly live Mobius Office Hours forum. Office Hours are hosted every Thursday at 8:30 am North American Pacific Time / 11:30 am Eastern Time and are open to everyone. To sign up, please visit Mobius Office Hours Sign-up: mobiustrimmer.com/contact/office-hours/.

GMP GUIDE

If your organization is considering GMP certification for any of its products, our *Guide to GMP-Certified Post-Harvest Processing* is a great place to start! mobiustrimmer.com/gmp-certified-cannabis-trimming/

SUPPORT

Looking for additional technical support? Please get in touch with us via phone, email, web, or live chat. Contact details are available at <https://mobiustrimmer.com/contact/customer-support/>.

Warranty submissions can be made online at <https://mobiustrimmer.com/contact/warranty-submission/>.

PARTS ORDERS

Most replacement parts can be found on the online Mobius store at <https://mobiustrimmer.com/replacement-parts/> or feel free to email us at orders@mobiustrimmer.com or call us at 1-866-874-6244 to place your order.

TROUBLESHOOTING







Problem	Resolution
Tumbler not spinning or moving only with difficulty	<ul style="list-style-type: none"> Assess amp draw (normal 0.3 – 0.4 amps) Clean Lid Bearings (instructional video: mobiustrimmer.com/instructions/lid-bearing-removal-installation/) If bearings are clicking or moving roughly, consider replacing them
Difficult to install retaining ring for tumbler	<ul style="list-style-type: none"> Check pump connection to spring jack, particularly the engagement tab if using a hand pump Ensure tumbler wires are straight, not twisted
Trim collecting in exhaust filter bag	<ul style="list-style-type: none"> Ensure machine is stopped and the trim tote is emptied before it fills to full Ensure trim tote and gasket are in good condition and properly installed Ensure machine is stopped and impeller has slowed down before removing and emptying trim tote Ensure separator window and fascia are properly installed (mobiustrimmer.com/instructions/separator-removal-installation/)
Dials not adjusting properly or can be turned with no stop at top or bottom of range	<ul style="list-style-type: none"> Check set screws on potentiometer dials Replace Pot board
Linear actuators not working	<ul style="list-style-type: none"> Assess/reset contactor
Blade VFD Error	<ul style="list-style-type: none"> Check for debris behind drive pulley Hard reset (unplug machine, wait 10 seconds, and plug in again)
Lid won't close	<ul style="list-style-type: none"> Hand spin tumbler end slightly to allow gears to properly mesh Ensure trimming system is seated correctly/not heavily soiled
Triple VFD error?	<ul style="list-style-type: none"> Check for kief dust in contactor coil Clean out electrical box

Need additional technical assistance? Please get in touch with us via phone, email, web, or live chat. Contact details are available at mobiustrimmer.com/contact/customer-support/.

SPECIFICATIONS

TECHNICAL SPECIFICATIONS

Detailed technical specifications are available on the Mobius website at mobiustrimmer.com/cannabis-automation/m108s-bud-trimmer/#resources

TRIM METHODOLOGY	THROUGHPUT																		
WET/DRY CAPABLE	YES																		
CONSTRUCTION	ANODIZED ALUMINUM & 304 STAINLESS STEEL																		
SPEED ADJUSTMENT	1 - 11																		
NUMBER OF BLADES	3																		
BLADE TREATMENT	NITRIDED																		
VACUUM MOTOR	5 HP																		
TUMBLER MOTOR	1/8 HP																		
CUTTER MOTOR	3/4 HP																		
TOOL-LESS DISASSEMBLY	YES																		
TANDEM READY	YES																		
INTEGRATED TILT ANGLE	YES																		
FITS THROUGH A 32" DOOR	YES																		
TUMBLER DIAMETER	8" / 20 CM																		
TUMBLER LENGTH	36" / 91 CM																		
DIMENSIONS	43" W X 43.5" L X 47" H / 109 CM X 111 CM X 119 CM																		
LENGTH (WITH SHROUDS IN PLACE)	77.5" / 192 CM																		
WEIGHT	500 LBS / 227 KG																		
POWER REQUIREMENTS NORTH AMERICA	<table border="0"> <tr> <td>Option 1</td> <td></td> <td>Option 2</td> </tr> <tr> <td>THREE PHASE: 208 V, 22 AMPS</td> <td></td> <td>SINGLE PHASE: 240 V, 30 AMPS (use ≥ 35 AMP breaker)</td> </tr> <tr> <td>L15-30R</td> <td>X L1</td> <td>X L1</td> </tr> <tr> <td></td> <td>Y L2</td> <td>Y L2</td> </tr> <tr> <td></td> <td>Z L3</td> <td>G GROUND</td> </tr> <tr> <td></td> <td>G GROUND</td> <td></td> </tr> </table>	Option 1		Option 2	THREE PHASE: 208 V, 22 AMPS		SINGLE PHASE: 240 V, 30 AMPS (use ≥ 35 AMP breaker)	L15-30R	X L1	X L1		Y L2	Y L2		Z L3	G GROUND		G GROUND	
Option 1		Option 2																	
THREE PHASE: 208 V, 22 AMPS		SINGLE PHASE: 240 V, 30 AMPS (use ≥ 35 AMP breaker)																	
L15-30R	X L1	X L1																	
	Y L2	Y L2																	
	Z L3	G GROUND																	
	G GROUND																		
POWER REQUIREMENTS INTERNATIONAL	<table border="0"> <tr> <td>THREE PHASE: 380 V, 10 AMPS</td> </tr> <tr> <td>L17-30R</td> </tr> <tr> <td></td> </tr> <tr> <td>X L1</td> </tr> <tr> <td>Y L2</td> </tr> <tr> <td>Z L3</td> </tr> <tr> <td>G GROUND</td> </tr> </table>	THREE PHASE: 380 V, 10 AMPS	L17-30R		X L1	Y L2	Z L3	G GROUND											
THREE PHASE: 380 V, 10 AMPS																			
L17-30R																			
																			
X L1																			
Y L2																			
Z L3																			
G GROUND																			
WARRANTY	1 YEAR or 1,000 HOURS																		
CERTIFICATIONS	ETL (CSA & UL EQUIVALENT), CE certified																		

MATERIAL SPECIFICATIONS

Detailed material specifications are available on the Mobius website at mobiustrimmer.com/cannabis-automation/m108s-bud-trimmer/#resources