

COMMERCIAL SOLUTIONS DESIGNED SPECIFICALLY FOR INDOOR CANNABIS CULTIVATION

## THE CHARIOT - 5' ROLLING BENCH

### GPS-ST-5X8

Our commercial grade rolling benches were designed with the commercial grower in mind. The stainless steel base will stand up to the rigorous and high humidity environments of indoor and greenhouse cannabis cultivations. Our bench will outlast any of the competition on the market. Maximize every inch of your grow space with our benches that have the biggest side to side travel on the market. The benches can go from touching each other to spread apart for a full 36" walkway. Most importantly each 8' section ships in its own box which makes installation super efficient, no missing or mystery parts, the only tool required is a battery powered drill. Anyone can set them up.

### INTENDED APPLICATIONS

- Green House
- Maximizing Canopy Space
- Indoor Cultivation
- Basement Grows

**STAINLESS STEEL!  
THE GAME CHANGER**

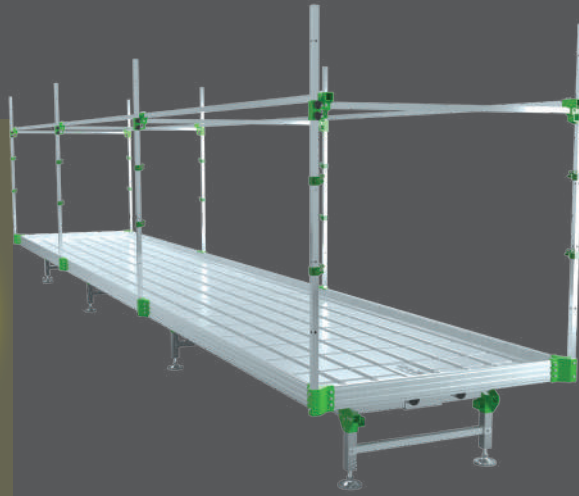

### FEATURES & BENEFITS

- Available in 4 foot and 5 foot widths.
- Individually boxed sections ensure straight forward and quick assembly.
- Crafted with almost twice the amount of steel and aluminum than your typical rolling bench.
- Base is made of high grade stainless steel and the green leg junctions are made of thick dye cast aluminum.
- Comes with handwheel for easy side to side movement.
- Included High Grade UV resistant plastic trays can hold up to 16lbs/sqft.
- Maximum weight capacity per 8' long section is 2000lbs of fully loaded crops.
- Customizable lengths up to 56ft long.
- Each leg has 7.5" of adjustable height to make the perfect drainage slope over all distances.
- Included Fully Supported Trellis Structure is designed to hold the weight of your maximum wet yield.
- 2 full sets of height adjustable trellis hooks allow for easy trellis installation and harvest.

### MODULAR TELESCOPIC DESIGN

Benches are designed to be quickly installed to specified lengths.

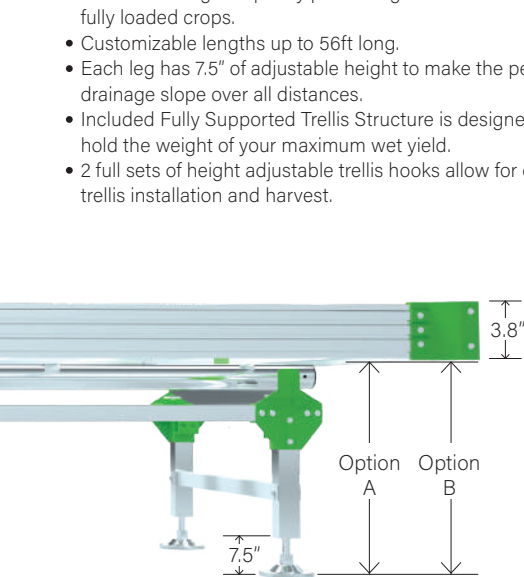
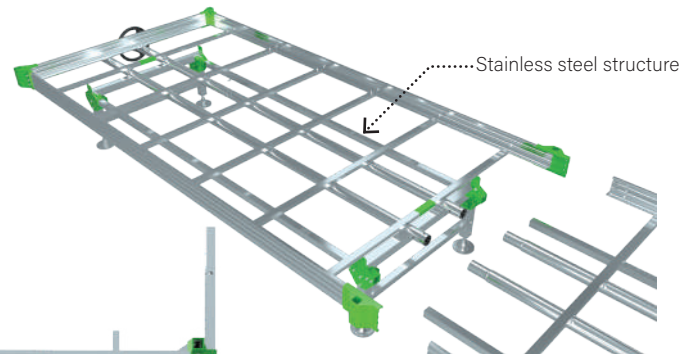

### ADJUSTABLE HEIGHT

- A) STANDARD; 1ft legs can be adjusted from 14" from ground to the bottom of the tray up to 21.5".
- B) CUSTOMIZED; 2ft legs can be adjusted from 25" from ground to the bottom of the tray up to 32.5". (Extra Charge).

