

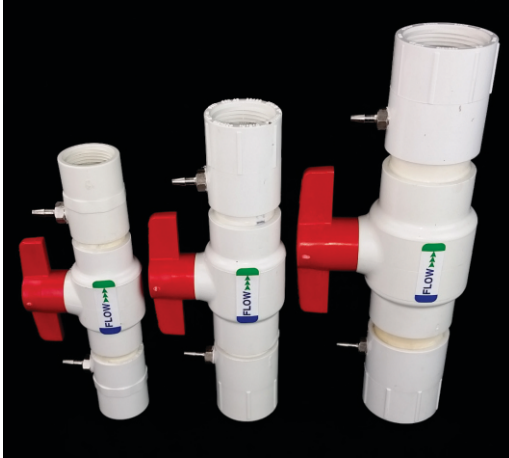

INJECTION SYSTEMS

INSTALLATION AND OPERATING GUIDE Coupling Ball Valve Threaded



(PRODUCT COLOR MAY VARY)

**For an overview of the EZ-FLO System
Installation & Operation:**

www.ezfloinjection.com

*** IMPORTANT ***

***READ INSTRUCTIONS BEFORE INSTALLING THE SYSTEM
TO INSURE PROPER INSTALLATION***

**EZ-FLO Injection Systems
Sold Separately**

- Do not connect to an irrigation system that is not protected by an approved back flow prevention device.
- Do not install if pressure exceeds 80 PSI
- Use only with non-hazardous products
- Minimize exposure to direct sunlight to maximize service life
- Protect against freezing to avoid fracture

Installation Overview

Irrigation Mainline - Multi Zone Injection (most common)

The EZ-FLO Mainline Injection systems are normally installed in a valve box, connected to the main line of the irrigation system after the back flow preventer. This will allow the system to inject to any irrigation zone valve located after the installation point. **One unit will feed both drip and sprinkler zones automatically adjusting for pressure and flow.**

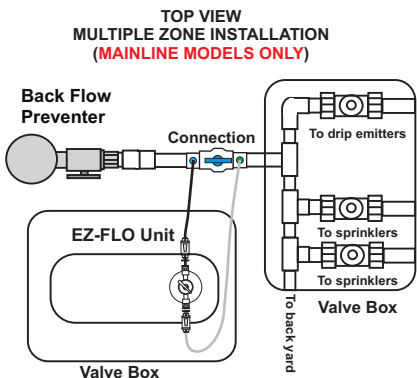

FEEDS ALL IRRIGATIONS ZONES

HIGH PRESSURE MAINLINE
SYSTEM REQUIRED

INSTALL ANYWHERE BETWEEN BACK
FLO PREVENTER AND FIRST ZONE VALVE

Irrigation Lateral Line - Single Zone Injection

The EZ-FLO Injection systems are normally installed in a valve box, connected to the main line of the irrigation system after the back flow preventer. There is the option to install an EZ-FLO on a single irrigation valve to isolate product delivery. Unit will feed drip, spray, or subsurface irrigation.

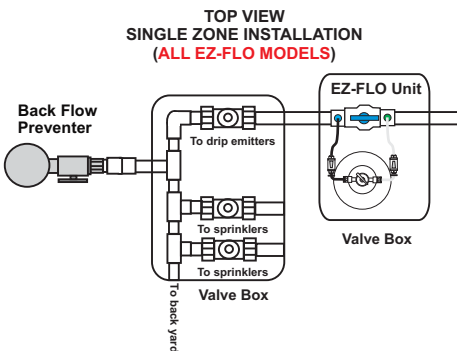

FEEDS ONE ZONE ONLY

HIGH PRESSURE TANK NOT REQUIRED

INSTALL ANYWHERE AFTER
THE ZONE VALVE

***NOTE:** When the EZ-FLO system is **not installed** on the irrigation mainline, additional backflow prevention may not be required. Some irrigation systems utilize individual zone backflow protection

Step 1 - Locate the installation point and pipe size

Connection must be made after an approved back flow prevention device.*

The connection can be made either **vertically or horizontally** in the irrigation main line.

The connection may be installed **above or below** the tank without issue.

The connection may be **any distance** from the back flow prevention device.

Use only the correct size connection for the installation as indicated on the CBV box label.

Part#	Mainline Size
CBVT-075	3/4"
CBVT-100	1"
CBVT-125	1.25"

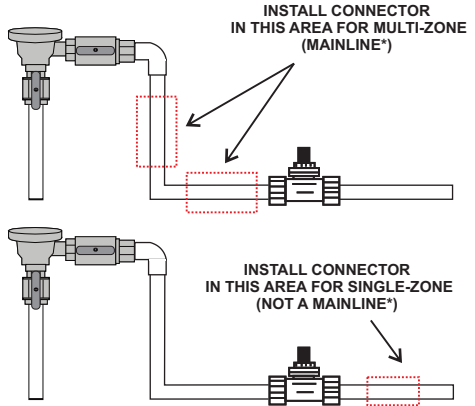

Do not use reducing bushings on the CBV unless directed to by an EZ-FLO representative (does not apply to CBV-100).

If your irrigation mainline has multiple diameters, such as a pump discharge to a larger mainline, it is best to install in the smallest diameter available to obtain best performance.

*Installations on a mainline may only be used with a mainline rated system. Installations after the zone valve may be used with any EZ-FLO model. Installations after a zone valve may not be subject to the same back flow requirements.

Step 2 - Shut off water and relieve pressure

You can use the valve on the back flow prevention device (pictured) or shut off your water main.

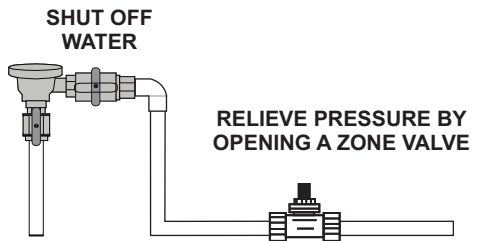

Main Line Connection

Step 3 - Cut out a section of pipe slightly larger than the cut out length of the coupling.

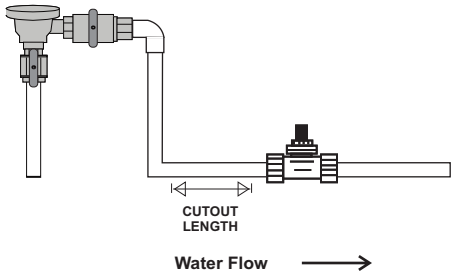
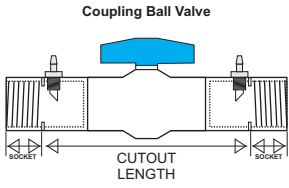

Step 4 - Thread the coupling into the line.

**Too much thread tape
can cause fittings to split**

**Over tightening of the
fitting may cause a split**

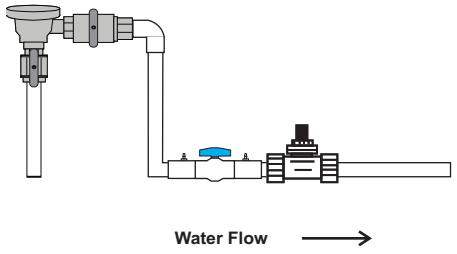

Step 5 - Attach tubing to the coupling.

**ATTACH BLACK TUBING TO BLUE
FITTING, CLEAR TUBING TO
GREEN FITTING AND SECURE
WITH TUBING CLAMPS**

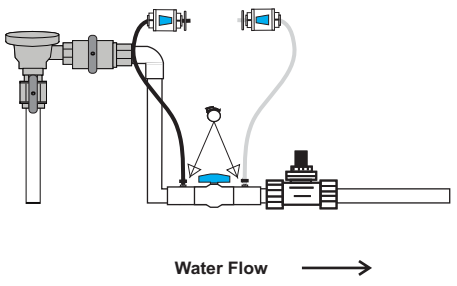

Connector Calibration - Coupling Ball Valve

The CBV connection must be calibrated to the flow rate of your irrigation system. If the irrigation system is higher flow, primarily composed of spray heads or larger drip irrigation zones, adjustment to the CBV may not be required.

The EZ-FLO system must be full of fertilizer which provides a color that can be used to indicate flow through the clear line. If your fertilizer is not colored, add blue or green dye to the tank.

Start by setting the proportioning cap adjustment setting to the **fast position** and the **CBV in full open position**.

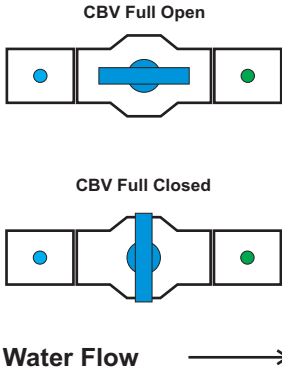
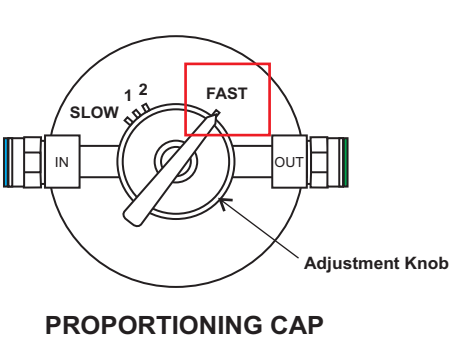

Step 9 - Turn on a sprinkler or drip zone with the closest to average gallons per minute flow rate and watch the clear, fertilizer-out tubing for color.

If color is steadily flowing through the clear output tube, the CBV does not require adjustment. Please note the color in the tube will be lighter than the color in the tank due to the mixing.

If color is not flowing through the clear tubing, slowly turn the CBV to the closed position in small increments, stopping once color begins to flow.

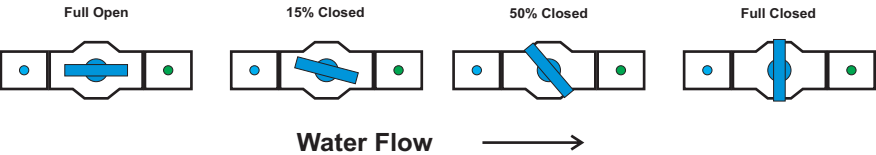

Once color is visible, you no longer have to adjust the CBV connection. You may leave it in position permanently.

To prove the system is working, adjust the feed setting back and forth. While the irrigation system is running, turn the knob from slow to fast, and fast to slow. Each time you adjust the knob to a new setting, the color in the tube will change. Slower settings are lighter and faster setting are darker.

Once all is confirmed, set the proportioning cap feed rate to the desired setting per your systems instructions.

For additional information, please read the FAQ/ Troubleshooting on page 6.

FAQ:

Why do I have to adjust the valve on the CBV: Your irrigation water flow is low and the system needs a bit of pressure to function properly.

Will adjusting the CBV impact my irrigation system performance: No, the pressure and flow is not lost, it is diverted through our system and reintroduced with the product.

Will the reduction in size/diameter impact my irrigation system performance: No, the reduction in diameter is short enough in length to not cause any issues.

How far away can the system be from the connector: We include (2) 5 ft lengths of tubing standard, but it may be installed up to 15 ft away with additional tubing.

Does the system have to be at the same level as the connection: No, it may be installed above or below the connection without concern. The connection may be horizontal or vertical in the piping.

How can I confirm it is working: With the irrigation system running, adjust the cap setting from slow to fast. Wait 5 to 10 seconds after adjusting and watch the color change. When on slow or turning to slow, the color will lighten. When on fast or turning to fast, the color will darken.

I see color at first, but then the line goes clear: This is normal during irrigation start up or zone cycles due to pressure spikes and drops. After the zone has been operational for at least 15 seconds, you should see color steadily flowing through the clear tube.

The system turned on and all the color flowed back into the tank: Similar to the above, this is standard when the tank is pressurizing. Color will begin flowing after the system reaches the correct pressure and injection starts.

Troubleshooting:

I cannot see color when closing the ball valve:

Confirm you have set the knob to fast.

Check to see that both shut off valves on the tubing are open.

Confirm you have a zone of irrigation running (water flowing).

Confirm you have added enough fertilizer and that it has a color.

My fertilizer is not dispensing: Repeat the calibration steps from page 5 and reference the above list.

My fertilizer is dispensing too fast: Check the cap setting and make sure you adjust to the correct feed rate.

My cap setting is correct, but my fertilizer is still feeding too fast: The CBV may be over adjusted to the closed position, repeat steps from page 5.

For more information and videos

